

## KRULL DIMENSION IN MODAL LOGIC

GURAM BEZHANISHVILI, NICK BEZHANISHVILI, JOEL LUCERO-BRYAN, AND JAN VAN MILL

**Abstract.** We develop the theory of Krull dimension for  $\mathbf{S4}$ -algebras and Heyting algebras. This leads to the concept of modal Krull dimension for topological spaces. We compare modal Krull dimension to other well-known dimension functions, and show that it can detect differences between topological spaces that Krull dimension is unable to detect. We prove that for a  $T_1$ -space to have a finite modal Krull dimension can be described by an appropriate generalization of the well-known concept of a nodec space. This, in turn, can be described by modal formulas  $\text{zem}_n$  which generalize the well-known Zeman formula  $\text{zem}$ . We show that the modal logic  $\mathbf{S4.Z}_n := \mathbf{S4} + \text{zem}_n$  is the basic modal logic of  $T_1$ -spaces of modal Krull dimension  $\leq n$ , and we construct a countable dense-in-itself  $\omega$ -resolvable Tychonoff space  $Z_n$  of modal Krull dimension  $n$  such that  $\mathbf{S4.Z}_n$  is complete with respect to  $Z_n$ . This yields a version of the McKinsey-Tarski theorem for  $\mathbf{S4.Z}_n$ . We also show that no logic in the interval  $[\mathbf{S4}_{n+1}, \mathbf{S4.Z}_n]$  is complete with respect to any class of  $T_1$ -spaces.

**§1. Introduction.** Topological semantics of modal logic was pioneered by Tsao-Chen [45], McKinsey [36], and McKinsey and Tarski [37]. The celebrated McKinsey–Tarski theorem states that if we interpret modal diamond as closure and hence modal box as interior, then  $\mathbf{S4}$  is the modal logic of any dense-in-itself separable metric space. Rasiowa and Sikorski [42] showed that separability can be dropped from the assumptions of the theorem. However, dropping the dense-in-itself assumption may result in logics strictly stronger than  $\mathbf{S4}$ . A complete description of when a modal logic is the logic of a metric space was given in [5], where it was shown that such logics form the chain:

$$\mathbf{S4} \subset \mathbf{S4.1} \subset \mathbf{S4.Grz} \subset \cdots \subset \mathbf{S4.Grz}_n \subset \cdots \subset \mathbf{S4.Grz}_1.$$

Here  $\mathbf{S4.1} = \mathbf{S4} + \Box\Diamond p \rightarrow \Diamond\Box p$  is the McKinsey logic,  $\mathbf{S4.Grz} = \mathbf{S4} + \Box(\Box(p \rightarrow \Box p) \rightarrow p) \rightarrow p$  is the Grzegorzczuk logic, and  $\mathbf{S4.Grz}_n = \mathbf{S4.Grz} + \text{bd}_n$ , where

$$\begin{aligned} \text{bd}_1 &= \Diamond\Box p_1 \rightarrow p_1, \\ \text{bd}_{n+1} &= \Diamond(\Box p_{n+1} \wedge \neg \text{bd}_n) \rightarrow p_{n+1}. \end{aligned}$$

An important generalization of the class of metric spaces is the class of Tychonoff spaces. It is a classic result of Tychonoff that these are exactly the spaces that up to homeomorphism are subspaces of compact Hausdorff spaces (see, e.g., [19, Theorem 3.2.6]). Because of this important feature, the class of Tychonoff spaces is

---

Received April 26, 2016.

2010 *Mathematics Subject Classification.* 03B45, 06E25, 06D20, 54F45, 54B17.

*Key words and phrases.* Krull dimension, modal logic, topological semantics, Heyting algebra.

one of the most studied classes of spaces in topology. For a Tychonoff space  $X$ , it is desirable to know the modal logic of  $X$ . This is a challenging open problem, and in this paper we obtain some results in this direction.

In determining the modal logic of a Kripke frame  $\mathfrak{F}$ , the depth of  $\mathfrak{F}$  plays an important role. It is well known (see, e.g., [10, Proposition 3.44 and Theorem 5.17]) that the depth of an **S4**-frame  $\mathfrak{F}$  is  $\leq n$  iff  $\mathfrak{F}$  validates  $\text{bd}_n$ , and that  $\mathbf{S4}_n := \mathbf{S4} + \text{bd}_n$  is the logic of the class of all **S4**-frames of depth  $\leq n$ . By Segerberg’s Theorem (see, e.g., [10, Theorem 8.85]),  $\mathbf{S4}_n$  and all its extensions are Kripke complete and have the finite model property.

In this paper we present a topological analogue of the depth of an **S4**-frame. This leads to a new concept of dimension in topology, which is closely related to the concept of Krull dimension in algebra and geometry (see, for example, [18, Chapter 8]). We recall that the Krull dimension of a commutative ring  $R$  is defined as the supremum of the lengths of finite chains of prime ideals of  $R$ . Since the spectrum  $\text{Spec}(R)$  of prime ideals of  $R$  topologized with the Zariski topology is a spectral space, where the inclusion on prime ideals is the specialization order of the Zariski topology, we can define the Krull dimension of a spectral space  $X$  as the supremum of the lengths of finite chains in the specialization order of  $X$ . By Stone duality [44], spectral spaces are dual to distributive lattices, which paves the way to defining the Krull dimension of a distributive lattice  $L$  as the supremum of the lengths of finite chains in  $(\text{Spec}(L), \subseteq)$ , where  $\text{Spec}(L)$  is the Stone dual of  $L$ . For different characterizations of the Krull dimension of distributive lattices see [8, 11, 12, 22, 23] and the references therein.

If we define the Krull dimension of an arbitrary topological space  $X$  by means of the specialization order of  $X$ , then to quote Isbell [29], the result is “spectacularly wrong for the most popular spaces, vanishing for all non-empty Hausdorff spaces; but it seems to be the only dimension of interest for the Zariski spaces of algebraic geometry.” Isbell remedied this by proposing the definition of graduated dimension. In this article we propose a different approach, which has its roots in modal logic. This leads to the concept of modal Krull dimension. As we will see, this notion is more refined. For example, every nonempty Stone space has Krull dimension and graduated dimension 0. On the other hand, for each  $n$  (including  $\infty$ ), there is a Stone space  $X$  such that the modal Krull dimension of  $X$  is  $n$ . Thus, modal Krull dimension provides a more refined classification of Stone spaces, and this extends to spectral spaces and beyond.

We start by developing the Krull dimension for **S4**-algebras (also known as closure algebras [37], topological Boolean algebras [42], and interior algebras [7]). An **S4**-algebra  $\mathfrak{A}$  has Krull dimension  $< n$  if the spectrum of ultrafilters of  $\mathfrak{A}$  has depth  $\leq n$  (see Definition 2.4). Since the spectrum of ultrafilters of  $\mathfrak{A}$  has depth  $\leq n$  iff  $\mathfrak{A}$  validates  $\text{bd}_n$  and  $\mathbf{S4}_n$  has the finite model property, it follows that  $\mathbf{S4}_n$  is the logic of the class of all **S4**-algebras of Krull dimension  $< n$ .

We introduce the modal Krull dimension of a topological space  $X$  as the Krull dimension of the **S4**-algebra of the powerset of  $X$ . We generalize the well-known concept of a nodec space to that of an  $n$ -nodec space, and prove that if  $X$  is a  $T_1$ -space, then the modal Krull dimension of  $X$  is  $\leq n$  iff  $X$  is  $n$ -nodec. As was shown in [3], the modal logic of the class of nodec spaces is the well-known Zeman logic **S4.Z**. For each  $n \geq 0$ , we generalize the Zeman logic **S4.Z** to the  $n$ -Zeman

logic  $\mathbf{S4.Z}_n$ , and show that  $\mathbf{S4.Z}_n$  is a proper extension of  $\mathbf{S4}_{n+1}$ . From this we derive that  $\mathbf{S4}_{n+1}$  and indeed any logic in the interval  $[\mathbf{S4}_{n+1}, \mathbf{S4.Z}_n)$  is topologically incomplete for any class of  $T_1$ -spaces. Therefore, there are infinitely many modal logics that are topologically incomplete with respect to Tychonoff spaces. Of course, all these logics are Kripke complete by Segerberg’s Theorem, and hence also topologically complete with respect to classes of topological spaces that are not  $T_1$  (indeed do not satisfy any separation axioms).

Consequently,  $\mathbf{S4.Z}_n$ , and not  $\mathbf{S4}_{n+1}$ , is the basic logic of Tychonoff spaces of modal Krull dimension  $\leq n$ . Moreover, it turns out that a version of the McKinsey-Tarski theorem holds for  $\mathbf{S4.Z}_n$ . Namely, for  $n \geq 1$ , we prove that  $\mathbf{S4.Z}_n$  is the logic of a countable dense-in-itself  $\omega$ -resolvable Tychonoff space  $Z_n$  of modal Krull dimension  $n$  (the case of  $n = 0$  is trivial since  $\mathbf{S4.Z}_0$  is the logic of any discrete space).

This is technically the most challenging result of the paper. It is proved by identifying a single  $\mathbf{S4}$ -frame  $\mathcal{Q}_{n+1}$  whose logic is  $\mathbf{S4.Z}_n$ , and constructing  $Z_n$  so that  $\mathcal{Q}_{n+1}$  is an interior image of  $Z_n$ . Since the depth of  $\mathcal{Q}_{n+1}$  is  $n + 1$ , this forces the modal Krull dimension of  $Z_n$  to be  $n$ ; and since there is no bound on the cluster size of  $\mathcal{Q}_{n+1}$ , this forces  $Z_n$  to be  $\omega$ -resolvable. As  $Z_n$  is countable, we obtain that  $\mathbf{S4.Z}_n$  has the countable model property with respect to Tychonoff spaces, and this is the best we can do since finite Tychonoff spaces are discrete, and hence  $\mathbf{S4.Z}_n$  cannot have the finite model property with respect to Tychonoff spaces. A complete description of extensions of  $\mathbf{S4.Z}_n$  that are complete with respect to Tychonoff spaces remains an open problem.

At the end of the paper, we utilize a close connection between  $\mathbf{S4}$ -algebras and Heyting algebras to develop the Krull dimension for Heyting algebras, and conclude with a brief comparison of modal Krull dimension to other well-known topological dimension functions.

**§2. Krull dimension of  $\mathbf{S4}$ -algebras.** We start by recalling that Lewis’ well-known modal system  $\mathbf{S4}$  is the least set of formulas in the basic modal language containing the classical tautologies, the formulas

- $\Box p \rightarrow p$ ,
- $\Box p \rightarrow \Box \Box p$ ,
- $\Box(p \rightarrow q) \rightarrow (\Box p \rightarrow \Box q)$ ,

and closed under modus ponens  $\frac{\varphi, \varphi \rightarrow \psi}{\psi}$ , substitution  $\frac{\varphi(p_1, \dots, p_n)}{\varphi(\psi_1, \dots, \psi_n)}$ , and necessitation  $\frac{\varphi}{\Box \varphi}$ .

Algebraic models of  $\mathbf{S4}$  are pairs  $\mathfrak{A} = (A, \Box)$ , where  $A$  is a Boolean algebra and  $\Box : A \rightarrow A$  is a unary function satisfying:

- $\Box a \leq a$ ,
- $\Box a \leq \Box \Box a$ ,
- $\Box(a \wedge b) = \Box a \wedge \Box b$ ,
- $\Box 1 = 1$ .

As usual, the dual of  $\Box$  is defined as  $\Diamond a = -\Box -a$  for each  $a \in A$ .

These algebras were introduced by McKinsey and Tarski [37], in the  $\Diamond$  signature, under the name of *closure algebras*. The name is motivated by the fact that  $\Diamond$  generalizes the definition of closure in a topological space. They are also known under

the name of *topological Boolean algebras* [42] and *interior algebras* [7]. Nowadays it is common to call them **S4**-algebras.

The modal language is interpreted in an **S4**-algebra  $\mathfrak{A}$  by assigning to each propositional letter an element of  $\mathfrak{A}$ , interpreting the classical connectives as the corresponding operations of the Boolean reduct of  $\mathfrak{A}$ , and the modal box as the unary function  $\Box$ . A modal formula  $\varphi$  is *valid* in  $\mathfrak{A}$ , written  $\mathfrak{A} \models \varphi$ , provided  $\varphi$  is 1 under all assignments of the letters, and  $\varphi$  is *satisfiable* in  $\mathfrak{A}$  provided  $\neg\varphi$  is not valid in  $\mathfrak{A}$ . We say that  $\varphi$  is *valid* whenever  $\varphi$  is valid in every **S4**-algebra. It is well known that  $\varphi$  is a theorem of **S4** iff  $\varphi$  is valid.

Typical examples of **S4**-algebras come from topological and relational semantics for **S4**. For a topological space  $X$ , let  $\mathbf{I}_X$  and  $\mathbf{C}_X$  be interior and closure in  $X$ , respectively. When it is clear from the context, we drop the subscripts. It is easy to see that the powerset algebra  $\mathfrak{A}_X = (\wp(X), \mathbf{I}_X)$  is an **S4**-algebra, where  $\wp(X)$  is the powerset of  $X$ . By the McKinsey-Tarski representation theorem [37], every **S4**-algebra is represented as a subalgebra of  $\mathfrak{A}_X$  for some topological space  $X$ .

We recall that a *Kripke frame* is a pair  $\mathfrak{F} = (W, R)$ , where  $W$  is a set and  $R$  is a binary relation on  $W$ . If  $R$  is reflexive and transitive, then  $\mathfrak{F}$  is called an **S4**-frame. It is well known that **S4**-frames provide relational semantics for **S4**, hence the name. Given an **S4**-frame  $\mathfrak{F} = (W, R)$ ,  $w \in W$ , and  $A \subseteq W$ , let

- $R[w] = \{v \in W \mid wRv\}$ ,
- $\Box_R A = \{w \in W \mid R[w] \subseteq A\}$ ,
- $\Diamond_R A = \{w \in W \mid R[w] \cap A \neq \emptyset\}$ .

Then the powerset algebra  $\mathfrak{A}_{\mathfrak{F}} = (\wp(W), \Box_R)$  is an **S4**-algebra, and every **S4**-algebra is represented as a subalgebra of  $\mathfrak{A}_{\mathfrak{F}}$  for some **S4**-frame  $\mathfrak{F}$  (see [20, 31, 34]).

Every **S4**-frame  $\mathfrak{F} = (W, R)$  can be thought of as a special topological space as follows. Call  $U \subseteq W$  an *R-upset* if  $w \in U$  implies  $R[w] \subseteq U$  (*R-downsets* are defined dually). Let  $\tau_R$  be the collection of all *R*-upsets of  $\mathfrak{F}$ . Then  $\tau_R$  is a topology on  $W$  in which closure is  $\Diamond_R$  and every  $w \in W$  has the least open neighborhood  $R[w]$ . Such topological spaces are called *Alexandroff spaces*, and can alternatively be described as the topological spaces in which intersections of arbitrary families of opens are open. Conversely, every topological space  $X$  has its *specialization order*  $R$  defined by setting  $xRy$  iff  $x \in \mathbf{C}_X(\{y\})$ . It is easy to see that  $R$  is reflexive and transitive, and so  $(X, R)$  is an **S4**-frame. Moreover, if  $X$  is Alexandroff, then opens in  $X$  are exactly the *R*-upsets, and hence **S4**-frames are in one-to-one correspondence with Alexandroff spaces (see, e.g., [1, p. 238]).

In [20], Esakia put together Stone duality for Boolean algebras with relational representation of **S4**-algebras to obtain a full duality for **S4**-algebras. By Esakia duality, the categories of **S4**-algebras and Esakia spaces are dually equivalent.<sup>1</sup>

**DEFINITION 2.1.** A *Stone space* is a zero-dimensional compact Hausdorff space, and an *Esakia space* is an **S4**-frame  $\mathfrak{F} = (W, R)$  such that  $W$  is equipped with a Stone topology satisfying

- $R[w]$  is closed,
- $U$  clopen implies  $\Box_R U$  is clopen.

---

<sup>1</sup>An alternative duality for **S4**-algebras can be developed by means of descriptive **S4**-frames (see [27], [10, Chapter 8]).

The dual Esakia space of an **S4**-algebra  $\mathfrak{A}$  is the pair  $\mathfrak{A}_* = (W, R)$ , where  $W$  is the Stone space of  $A$  and

$$wRv \text{ iff } (\forall a \in \mathfrak{A})(\Box a \in w \Rightarrow a \in v).$$

The dual **S4**-algebra of an Esakia space  $\mathfrak{F} = (W, R)$  is the **S4**-algebra  $\mathfrak{F}^* = (\text{Clop}(W), \Box_R)$ , where  $\text{Clop}(W)$  is the Boolean algebra of clopen subsets of  $W$ . Then  $\beta : \mathfrak{A} \rightarrow \mathfrak{A}_*$  and  $\varepsilon : \mathfrak{F} \rightarrow \mathfrak{F}^*$  are isomorphisms, where

$$\beta(a) = \{w \in W \mid a \in w\} \text{ and } \varepsilon(w) = \{U \in \text{Clop}(W) \mid w \in U\}.$$

In the finite case, the topology on an Esakia space becomes discrete, and we identify finite Esakia spaces with finite **S4**-frames.

The modal language is interpreted in an Esakia space  $\mathfrak{F}$  by interpreting the modal formulas in the dual **S4**-algebra  $\mathfrak{F}^*$ . A modal formula  $\varphi$  is defined to be valid (resp. satisfiable) in  $\mathfrak{F}$  exactly when  $\varphi$  is valid (resp. satisfiable) in  $\mathfrak{F}^*$ . If  $\varphi$  is valid in  $\mathfrak{F}$ , then we write  $\mathfrak{F} \models \varphi$ .

Let  $\mathfrak{A}$  be an **S4**-algebra and  $\mathfrak{A}_*$  be the Esakia space of  $\mathfrak{A}$ . As is customary, we adopt topological terminology and call  $a \in \mathfrak{A}$  *closed* if  $a = \Diamond a$ , *open* if  $a = \Box a$ , *dense* if  $\Diamond a = 1$ , and *nowhere dense* if  $\Box \Diamond a = 0$ . The following is well known (and easy to see):

- $a$  is closed iff  $\beta(a)$  is a clopen  $R$ -downset in  $\mathfrak{A}_*$ ,
- $a$  is open iff  $\beta(a)$  is a clopen  $R$ -upset in  $\mathfrak{A}_*$ ,
- $a$  is dense iff  $\Diamond_R \beta(a) = W$ ,
- $a$  is nowhere dense iff  $\Box_R \Diamond_R \beta(a) = \emptyset$ .

The *relativization* of  $\mathfrak{A}$  to  $a \in \mathfrak{A}$  is the **S4**-algebra  $\mathfrak{A}_a$  whose underlying set is the interval  $[0, a]$ , the meet and join in  $\mathfrak{A}_a$  coincide with those in  $\mathfrak{A}$ , the complement of  $b \in \mathfrak{A}_a$  is given by  $a - b$ , the interior by  $\Box_a b = a \wedge \Box(a \rightarrow b)$ , and the closure by  $\Diamond_a b = a \wedge \Diamond b$ . If  $\mathfrak{A} = \mathfrak{A}_X$  is the powerset algebra of a topological space  $X$  and  $Y \subseteq X$ , then the relativization of  $\mathfrak{A}$  to  $Y$  is the powerset algebra  $\mathfrak{A}_Y$  of the subspace  $Y$  of  $X$ .<sup>2</sup> The relativization  $\mathfrak{A}_a$  is realized dually as the restriction of  $R$  to the clopen subspace  $\beta(a)$  of  $\mathfrak{A}_*$ . In order to describe dually a connection between nowhere dense elements and relativizations, we recall the notion of an  $R$ -maximal point.

**DEFINITION 2.2.** Let  $\mathfrak{F} = (W, R)$  be an **S4**-frame,  $U \subseteq W$ , and  $w \in U$ . Then  $w$  is an  $R$ -maximal point of  $U$  provided  $wRu$  and  $u \in U$  imply  $uRw$ . We denote the set of  $R$ -maximal points of  $U$  by  $\max_R(U)$ . If  $U = W$ , then we write  $\max_R(\mathfrak{F})$ .

It is well known (see, e.g., [21, Section III.2]) that in an Esakia space  $\mathfrak{F} = (W, R)$ , the set  $\max_R(\mathfrak{F})$  is a closed  $R$ -upset, and for each  $w \in W$  there is  $v \in \max_R(\mathfrak{F})$  such that  $wRv$ .

**LEMMA 2.3.** Let  $\mathfrak{A}$  be an **S4**-algebra and  $\mathfrak{A}_*$  be its Esakia space. Suppose  $a \in \mathfrak{A}$  and  $d \in \mathfrak{A}_a$ . Then  $d$  is nowhere dense in  $\mathfrak{A}_a$  iff  $\beta(d) \cap \max_Q \beta(a) = \emptyset$ , where  $Q$  is the restriction of  $R$  to  $\beta(a)$ .

**PROOF.** Since  $\mathfrak{A}_*$  is an Esakia space and  $\beta(a)$  is clopen in  $\mathfrak{A}_*$ , it is well known (see, e.g., [21, Section III.2]) that  $\mathfrak{F} = (\beta(a), Q)$  is also an Esakia space. As  $\max_Q \beta(a)$  is a  $Q$ -upset of  $\beta(a)$ , the condition  $\beta(d) \cap \max_Q \beta(a) = \emptyset$

---

<sup>2</sup>Despite subscript being used to denote both a relativization of an **S4**-algebra  $\mathfrak{A}$  and the powerset algebra of a space  $X$ , there is no ambiguity when  $\mathfrak{A} = \mathfrak{A}_X$  because  $(\mathfrak{A}_X)_Y = \mathfrak{A}_Y$ .

is equivalent to  $\diamond_Q[\beta(d)] \cap \max_Q\beta(a) = \emptyset$ , which in turn is equivalent to  $\Box_Q\diamond_Q[\beta(d)] \cap \max_Q\beta(a) = \emptyset$ . Since  $\Box_Q\diamond_Q[\beta(d)]$  is a  $Q$ -upset of  $\beta(a)$ , the last condition is equivalent to  $\Box_Q\diamond_Q[\beta(d)] = \emptyset$ . Therefore,  $\beta(d) \cap \max_Q\beta(a) = \emptyset$  iff  $\beta(\Box_a\diamond_a d) = \emptyset$ , which is equivalent to  $d$  being nowhere dense in  $\mathfrak{A}_a$ .  $\dashv$

For an **S4**-frame  $\mathfrak{F} = (W, R)$ , we write  $w\vec{R}v$  provided  $wRv$  and  $\neg(vRw)$ . We call a finite sequence  $\{w_i \in W \mid 0 \leq i < n\}$  an  $R$ -chain provided  $w_i\vec{R}w_{i+1}$  for all  $i$ , and define the length of the  $R$ -chain  $\{w_i \in W \mid 0 \leq i < n\}$  to be  $n - 1$ . Note that we allow the empty  $R$ -chain which has length  $-1$ .

DEFINITION 2.4. Let  $\mathfrak{A}$  be an **S4**-algebra. Define the Krull dimension  $\text{kdim}(\mathfrak{A})$  of  $\mathfrak{A}$  as the supremum of the lengths of  $R$ -chains in  $\mathfrak{A}_*$ . If the supremum is not finite, then we write  $\text{kdim}(\mathfrak{A}) = \infty$ .

The definition of the length of an  $R$ -chain that we have adopted has its roots in algebra. Modal logicians have used a similar concept of depth of a frame  $\mathfrak{F} = (W, R)$ . But in modal logic the length of an  $R$ -chain  $\{w_i \in W \mid 0 \leq i < n\}$  is typically defined to be  $n$ . This notion of length is always one more than the notion of length in algebra. The difference is whether we count the number of  $R$ -links in the  $R$ -chain (as algebraists do) or the number of points in the  $R$ -chain (as modal logicians do). Therefore, the Krull dimension of  $\mathfrak{A}$  is one less than the depth of  $\mathfrak{A}_*$  (provided the Krull dimension of  $\mathfrak{A}$  is finite). Thus,  $\text{kdim}(\mathfrak{A}) = n$  iff  $\text{depth}(\mathfrak{A}_*) = n + 1$  for  $n \in \omega$ .

The following well-known lemma (see, e.g., [10, Proposition 3.44]) measures the bound on the depth of  $\mathfrak{A}_*$ , and hence the bound on the Krull dimension of  $\mathfrak{A}$ , by means of the modal formulas  $\text{bd}_n$ .

LEMMA 2.5. Let  $\mathfrak{A}$  be a nontrivial **S4**-algebra and  $n \geq 1$ . Then  $\text{depth}(\mathfrak{A}_*) \leq n$  iff  $\mathfrak{A} \models \text{bd}_n$ .

It is relatively easy to describe when  $\text{kdim}(\mathfrak{A}) \leq 0$ . Recall that  $\mathfrak{A}$  is trivial if  $0 = 1$ , it is discrete if  $\Box$  is the identity function, and it is an **S5**-algebra (or monadic algebra) if  $a \leq \Box\diamond a$  for all  $a \in A$ . It is well known that  $\mathfrak{A}$  is trivial iff  $\mathfrak{A}_* = \emptyset$ , that  $\mathfrak{A}$  is discrete iff  $R$  is the identity, and that  $\mathfrak{A}$  is an **S5**-algebra iff  $R$  is an equivalence relation.

LEMMA 2.6. Let  $\mathfrak{A}$  be an **S4**-algebra.

1.  $\text{kdim}(\mathfrak{A}) = -1$  iff  $\mathfrak{A}$  is the trivial algebra.
2.  $\text{kdim}(\mathfrak{A}) \leq 0$  iff  $\mathfrak{A}$  is an **S5**-algebra.
3.  $\text{kdim}(\mathfrak{A}) = 0$  iff  $\mathfrak{A}$  is a nontrivial **S5**-algebra.
4. If  $\mathfrak{A}$  is discrete, then  $\text{kdim}(\mathfrak{A}) \leq 0$ .

PROOF. (1) Suppose  $\mathfrak{A}$  is trivial. Then  $\mathfrak{A}_* = \emptyset$ , so the only  $R$ -chain in  $\mathfrak{A}_*$  is the empty chain whose length is  $-1$ . Therefore,  $\text{kdim}(\mathfrak{A}) = -1$ . Conversely, if  $\text{kdim}(\mathfrak{A}) = -1$ , then every  $R$ -chain in  $\mathfrak{A}_*$  has length  $-1$ , and hence is the empty chain. Thus,  $\mathfrak{A}_* = \emptyset$ , and so  $\mathfrak{A}$  is the trivial algebra.

(2) Suppose  $\mathfrak{A}$  is an **S5**-algebra. Then  $R$  is an equivalence relation, so there are no  $w, v \in \mathfrak{A}_*$  with  $w\vec{R}v$ . Therefore, every  $R$ -chain in  $\mathfrak{A}_*$  has length  $\leq 0$ . Thus,  $\text{kdim}(\mathfrak{A}) \leq 0$ . Conversely, suppose  $\text{kdim}(\mathfrak{A}) \leq 0$ . Then every  $R$ -chain in  $\mathfrak{A}_*$  has length  $\leq 0$ . Therefore, if  $xRy$ , then it cannot be the case that  $\neg(yRx)$ . Thus,  $R$  is symmetric, and so  $\mathfrak{A}$  is an **S5**-algebra.

(3) This follows from (1) and (2).

(4) This follows from (2) since every discrete algebra is an **S5**-algebra.  $\dashv$

REMARK 2.7.

1. Since not every **S5**-algebra is discrete, the converse of Lemma 2.6(4) does not hold.
2. Suppose  $\mathfrak{A}$  is a subalgebra of  $\mathfrak{A}_X$  for some topological space  $X$ . If  $\mathfrak{A}$  consists of clopen subsets of  $X$ , then  $\mathfrak{A}$  is discrete, and hence  $\text{kdim}(\mathfrak{A}) \leq 0$ .

By Lemma 2.6, whether the Krull dimension of  $\mathfrak{A}$  is  $\leq 0$  can be determined internally in  $\mathfrak{A}$ , without accessing  $\mathfrak{A}_*$ . The goal of the remainder of this section is to develop a pointfree description of the Krull dimension of  $\mathfrak{A}$  that does not require the Esakia space of  $\mathfrak{A}$ . In fact, we will prove that  $\text{kdim}(\mathfrak{A})$  can be defined recursively as follows.

DEFINITION 2.8. The *Krull dimension*  $\text{kdim}(\mathfrak{A})$  of an **S4**-algebra  $\mathfrak{A}$  can be defined as follows:

$$\begin{aligned} \text{kdim}(\mathfrak{A}) &= -1 && \text{if } \mathfrak{A} \text{ is the trivial algebra,} \\ \text{kdim}(\mathfrak{A}) &\leq n && \text{if } \text{kdim}(\mathfrak{A}_d) \leq n - 1 \text{ for every nowhere dense } d \in \mathfrak{A}, \\ \text{kdim}(\mathfrak{A}) &= n && \text{if } \text{kdim}(\mathfrak{A}) \leq n \text{ and } \text{kdim}(\mathfrak{A}) \not\leq n - 1, \\ \text{kdim}(\mathfrak{A}) &= \infty && \text{if } \text{kdim}(\mathfrak{A}) \not\leq n \text{ for any } n = -1, 0, 1, 2, \dots \end{aligned}$$

To show that Definitions 2.4 and 2.8 are equivalent requires some preparation. For now we refer to Definition 2.4 as the *external Krull dimension* and to Definition 2.8 as the *internal Krull dimension* of  $\mathfrak{A}$ .

LEMMA 2.9. Let  $\mathfrak{A}$  be an **S4**-algebra,  $a \in \mathfrak{A}$ , and  $d \in \mathfrak{A}_a$ . If  $d$  is nowhere dense in  $\mathfrak{A}_a$ , then  $d$  is nowhere dense in  $\mathfrak{A}$ .

PROOF. Set  $u = \Box \Diamond d$ . Then

$$\begin{aligned} d \wedge u &= d \wedge \Box \Diamond d \leq a \wedge \Box \Diamond d \leq a \wedge \Box(a \rightarrow \Diamond d) \\ &= a \wedge \Box(a \rightarrow (a \wedge \Diamond d)) = \Box_a \Diamond_a d = 0. \end{aligned}$$

Therefore,  $d \leq -u$ . Since  $u$  is open,  $-u$  is closed, so  $\Diamond d \leq -u$ , giving  $u \wedge \Diamond d = 0$ . Thus,  $u = 0$ , and hence  $d$  is nowhere dense in  $\mathfrak{A}$ . □

DEFINITION 2.10. Let  $n \geq 0$  and  $a_1, \dots, a_{n+1} \in \mathfrak{A}$ . Define  $d_0, \dots, d_{n+1}$  and  $e_0, \dots, e_n$  recursively as follows, where  $0 \leq i \leq n$ :

$$\begin{aligned} d_0 &= 1, \\ e_i &= \Diamond(\Box a_{i+1} \wedge d_i), \\ d_{i+1} &= e_i - a_{i+1}. \end{aligned}$$

Let  $n \geq 1$ . It is straightforward to see that if we interpret  $p_i$  as  $a_i$  for  $1 \leq i \leq n$ , then the formula  $\neg \text{bd}_n$  is interpreted as  $d_n$ , and the antecedent of  $\text{bd}_n$  as  $e_{n-1}$ .

LEMMA 2.11. Let  $n \geq 0$ ,  $\mathfrak{A}$  be an **S4**-algebra,  $a_1, \dots, a_{n+1} \in \mathfrak{A}$ , and  $d_0, \dots, d_{n+1}$  and  $e_0, \dots, e_n$  be defined as in Definition 2.10.

1.  $e_1$  is nowhere dense in  $\mathfrak{A}$ .
2.  $e_{i+1}$  is nowhere dense in  $\mathfrak{A}_{e_i}$  for  $1 \leq i < n$ .

PROOF. (1) Since  $e_0 = \Diamond \Box a_1$  is closed, we have

$$\Box \Diamond d_1 = \Box \Diamond(e_0 - a_1) \leq \Box(e_0 - \Box a_1) = \Box e_0 - \Diamond \Box a_1 \leq e_0 - e_0 = 0.$$

Therefore,  $d_1$  is nowhere dense in  $\mathfrak{A}$ . This yields that  $\Box a_2 \wedge d_1$  is nowhere dense in  $\mathfrak{A}$ . Thus,  $e_1 = \Diamond(\Box a_2 \wedge d_1)$  is nowhere dense in  $\mathfrak{A}$ .



(2) For  $1 \leq i < n$ , we have  $e_{i+1} \leq \diamond d_{i+1} \leq \diamond e_i = e_i$ , and so  $e_{i+1} \in \mathfrak{A}_{e_i}$ . Since  $e_{i+1} = \diamond(\Box a_{i+2} \wedge d_{i+1})$ , it is sufficient to show  $\Box a_{i+2} \wedge d_{i+1}$  is nowhere dense in  $\mathfrak{A}_{e_i}$ . Because  $e_i$  is closed in  $\mathfrak{A}$ , we have  $\diamond_{e_i} a = \diamond a$  for all  $a \leq e_i$ . To see that  $\Box a_{i+2} \wedge d_{i+1}$  is nowhere dense in  $\mathfrak{A}_{e_i}$ , let  $u$  be open in  $\mathfrak{A}_{e_i}$  with  $u \leq \diamond(\Box a_{i+2} \wedge d_{i+1})$ . We set  $u' = u \wedge \Box a_{i+1}$ . Then  $u'$  is open in  $\mathfrak{A}_{e_i}$  and  $u' \leq a_{i+1}$ , so

$$\begin{aligned} u' \wedge \Box a_{i+2} \wedge d_{i+1} &= u' \wedge \Box a_{i+2} \wedge (e_i - a_{i+1}) \\ &\leq u' \wedge (e_i - a_{i+1}) = u' - a_{i+1} = 0. \end{aligned}$$

Therefore,  $u' \wedge \diamond(\Box a_{i+2} \wedge d_{i+1}) = 0$ . This together with  $u' \leq u \leq \diamond(\Box a_{i+2} \wedge d_{i+1})$  yields that  $u' = 0$ . Thus,  $u \wedge \Box a_{i+1} = 0$ , and so  $u \wedge \Box a_{i+1} \wedge d_i = 0$ . But  $\Box a_{i+1} \wedge d_i$  is dense in  $\mathfrak{A}_{e_i}$ , giving that  $u = 0$ . Consequently,  $\Box a_{i+2} \wedge d_{i+1}$  is nowhere dense in  $\mathfrak{A}_{e_i}$ .  $\dashv$

The next lemma concerns the internal Krull dimension of an **S4**-algebra.

LEMMA 2.12. *Let  $\mathfrak{A}$  be an **S4**-algebra.*

1. For  $a \in \mathfrak{A}$ , we have  $\text{kdim}(\mathfrak{A}_a) \leq \text{kdim}(\mathfrak{A})$ .
2.  $\text{kdim}(\mathfrak{A}) \leq n$  iff  $\text{kdim}(\mathfrak{A}_d) \leq n - 1$  for every closed nowhere dense  $d \in \mathfrak{A}$ .

PROOF. (1) If  $\text{kdim}(\mathfrak{A}) = \infty$ , then there is nothing to prove. Suppose  $\text{kdim}(\mathfrak{A}) = n$ . Let  $d \in \mathfrak{A}_a$  be nowhere dense in  $\mathfrak{A}_a$ . By Lemma 2.9,  $d$  is nowhere dense in  $\mathfrak{A}$ . Since  $\text{kdim}(\mathfrak{A}) = n$ , we see that  $\text{kdim}(\mathfrak{A}_d) \leq n - 1$ . Because  $(\mathfrak{A}_a)_d = \mathfrak{A}_d$ , we conclude that  $\text{kdim}(\mathfrak{A}_a) \leq n$ . Thus,  $\text{kdim}(\mathfrak{A}_a) \leq \text{kdim}(\mathfrak{A})$ .

(2) One implication is trivial. For the other, let  $d$  be nowhere dense in  $\mathfrak{A}$ . Then  $\diamond d$  is closed and nowhere dense in  $\mathfrak{A}$ . Therefore,  $\text{kdim}(\mathfrak{A}_{\diamond d}) \leq n - 1$ . Thus, (1) yields  $\text{kdim}(\mathfrak{A}_d) = \text{kdim}((\mathfrak{A}_{\diamond d})_d) \leq \text{kdim}(\mathfrak{A}_{\diamond d}) \leq n - 1$ . Consequently,  $\text{kdim}(\mathfrak{A}) \leq n$ .  $\dashv$

We next recall the notion of an Esakia morphism between Esakia spaces.

DEFINITION 2.13. Suppose  $\mathfrak{F} = (W, R)$  and  $\mathfrak{G} = (V, Q)$  are Esakia spaces.

1. A map  $f : W \rightarrow V$  is a *p-morphism* provided  $R[f(w)] = f(R[w])$  for all  $w \in W$ .
2. An *Esakia morphism* is a continuous p-morphism  $f : W \rightarrow V$ .

It is well known (see, e.g., [21, Section IV.3]) that Esakia morphisms correspond dually to **S4**-algebra homomorphisms; that is,  $h : \mathfrak{A} \rightarrow \mathfrak{B}$  is an **S4**-algebra homomorphism iff  $h_* : \mathfrak{B}_* \rightarrow \mathfrak{A}_*$  is an Esakia morphism, where  $h_*(w) = h^{-1}(w)$ . Moreover,  $h$  is 1-1 (resp. onto) iff  $h_*$  is onto (resp. 1-1).

We call an **S4**-frame  $\mathfrak{F} = (W, R)$  *rooted* if there is  $r \in W$  with  $W = R[r]$ . We refer to  $r$  as a root of  $\mathfrak{F}$ . In general,  $r$  is not unique. Let  $\mathfrak{F} = (W, R)$  be a finite rooted **S4**-frame. It is well known [24, 30] that with  $\mathfrak{F}$  we can associate the *Jankov–Fine formula*  $\chi_{\mathfrak{F}}$ , which satisfies the following property:

$\chi_{\mathfrak{F}}$  is satisfiable in an Esakia space  $\mathfrak{G}$  iff there is an Esakia space  $\mathfrak{E}$  and Esakia morphisms  $\mathfrak{F} \xleftarrow{f} \mathfrak{E} \xrightarrow{g} \mathfrak{G}$  such that  $f$  is onto and  $g$  is 1-1.

Let  $\mathfrak{F}_n = (W_n, R)$  be the  $n$ -element chain, where  $W_n = \{w_0, \dots, w_{n-1}\}$  and  $w_i R w_j$  iff  $j \leq i$ ; see Figure 1.

We are ready to characterize the internal Krull dimension of an **S4**-algebra.



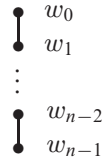

FIGURE 1. The  $n$ -element chain.

**THEOREM 2.14.** *Let  $\mathfrak{A}$  be a nontrivial **S4**-algebra and  $n \geq 1$ . The following are equivalent:*

1.  $\text{kdim}(\mathfrak{A}) \leq n - 1$ .
2. *There does not exist a sequence  $c_0, \dots, c_n$  of nonzero closed elements of  $\mathfrak{A}$  such that  $c_0 = 1$  and  $c_{i+1}$  is nowhere dense in  $\mathfrak{A}_{c_i}$  for each  $i \in \{0, \dots, n - 1\}$ .*
3.  $\mathfrak{A} \models \text{bd}_n$ .
4.  $\text{depth}(\mathfrak{A}_*) \leq n$ .
5.  $\mathfrak{A} \models \neg \chi_{\mathfrak{F}_{n+1}}$ .
6.  $\mathfrak{F}_{n+1}^*$  is not isomorphic to a subalgebra of a homomorphic image of  $\mathfrak{A}$ .
7. *There do not exist an Esakia space  $\mathfrak{G}$  and Esakia morphisms  $\mathfrak{F}_{n+1} \xleftarrow{f} \mathfrak{G} \xrightarrow{g} \mathfrak{A}_*$  such that  $f$  is onto and  $g$  is 1-1.*
8.  $\mathfrak{F}_{n+1}^*$  is not isomorphic to a subalgebra of  $\mathfrak{A}$ .
9.  $\mathfrak{F}_{n+1}$  is not an image of  $\mathfrak{A}_*$  under an onto Esakia morphism.

**PROOF.** (1) $\Rightarrow$ (2): Induction on  $n$ . Let  $n = 1$ . Since  $\mathfrak{A}$  is nontrivial,  $\text{kdim}(\mathfrak{A}) \leq 0$  yields  $\text{kdim}(\mathfrak{A}) = 0$ . Therefore, for any nowhere dense  $d$  in  $\mathfrak{A}$ , we have  $\text{kdim}(\mathfrak{A}_d) = -1$ , so  $\mathfrak{A}_d$  is trivial, and hence  $d = 0$ . Thus,  $\mathfrak{A}$  has no nonzero closed nowhere dense elements, as required. Next let  $n > 1$  and  $\text{kdim}(\mathfrak{A}) \leq n - 1$ . Suppose there is a sequence  $c_0, \dots, c_n$  of nonzero closed elements of  $\mathfrak{A}$  such that  $c_0 = 1$  and  $c_{i+1}$  is nowhere dense in  $\mathfrak{A}_{c_i}$  for each  $i \in \{0, \dots, n - 1\}$ . Then  $c_1, \dots, c_n$  is a sequence of nonzero closed elements of  $\mathfrak{A}_{c_1}$  such that  $c_{i+1}$  is nowhere dense in  $\mathfrak{A}_{c_i}$  for each  $i \in \{1, \dots, n - 1\}$ . By the induction hypothesis, applied to  $\mathfrak{A}_{c_1}$ , we have  $\text{kdim}(\mathfrak{A}_{c_1}) > n - 1$ . Since  $c_1$  is nowhere dense in  $\mathfrak{A}$  with  $\text{kdim}(\mathfrak{A}_{c_1}) > n - 1$ , we conclude that  $\text{kdim}(\mathfrak{A}) > n$ . This contradicts (1).

(2) $\Rightarrow$ (3): If  $\mathfrak{A} \not\models \text{bd}_n$ , then there exist  $a_1, \dots, a_n \in \mathfrak{A}$  such that  $d_n \neq 0$ , where  $d_n$  is defined as in Definition 2.10. Put  $a_{n+1} = 1$  and let  $e_0, \dots, e_n$  be defined as in Definition 2.10. Observe that

$$e_n = \diamond(\Box a_{n+1} \wedge d_n) = \diamond(\Box 1 \wedge d_n) = \diamond d_n \geq d_n \neq 0.$$

Set  $c_0 = 1$  and  $c_i = e_i$  for  $1 \leq i \leq n$ . Then  $c_0, \dots, c_n$  is a sequence of nonzero closed elements in  $\mathfrak{A}$  such that  $c_0 = 1$  and, by Lemma 2.11,  $c_{i+1}$  is nowhere dense in  $\mathfrak{A}_{c_i}$  for each  $i \in \{0, \dots, n - 1\}$ .

(3) $\Rightarrow$ (1): Suppose that  $\text{kdim}(\mathfrak{A}) > n - 1$ . We define a decreasing sequence  $b_0, \dots, b_n$  of closed elements in  $\mathfrak{A}$  such that  $b_{i+1}$  is nowhere dense in  $\mathfrak{A}_{b_i}$  and  $\text{kdim}(\mathfrak{A}_{b_{i+1}}) > (n - 1) - (i + 1)$ . Set  $b_0 = 1$ . If  $b_i$  is already defined with  $\text{kdim}(\mathfrak{A}_{b_i}) > (n - 1) - i$ , then by Lemma 2.12(2), there is a closed nowhere dense  $b_{i+1} \in \mathfrak{A}_{b_i}$  such that  $\text{kdim}(\mathfrak{A}_{b_{i+1}}) > (n - 1) - (i + 1)$ . Noting that  $\text{kdim}(\mathfrak{A}_{b_n}) > (n - 1) - n = -1$ , it follows that  $\mathfrak{A}_{b_n}$  is not trivial, and hence  $b_n \neq 0$ .

Let  $a_i = -b_i$  for  $1 \leq i \leq n$ . Let  $d_0, \dots, d_n$  be defined from  $a_1, \dots, a_n$  as in Definition 2.10. We show that  $b_i = d_i$  for each  $0 \leq i \leq n$ . If  $i = 0$ , then  $b_0 = 1 = d_0$ .

Next suppose that  $b_i = d_i$  for  $0 \leq i < n$ , and show that  $b_{i+1} = d_{i+1}$ . Since  $a_{i+1}$  is open in  $\mathfrak{A}$ ,  $b_{i+1}$  is nowhere dense in  $\mathfrak{A}_{b_i}$ , and  $b_i$  is closed in  $\mathfrak{A}$ , we have

$$\begin{aligned} b_{i+1} &= b_i \wedge b_{i+1} = \diamond(b_i - b_{i+1}) \wedge b_{i+1} = \diamond(b_i - b_{i+1}) - (-b_{i+1}) \\ &= \diamond(a_{i+1} \wedge b_i) - a_{i+1} = \diamond(\Box a_{i+1} \wedge d_i) - a_{i+1} = d_{i+1}. \end{aligned}$$

Thus,  $d_n = b_n \neq 0$ . Since  $\neg bd_n$  is interpreted in  $\mathfrak{A}$  as  $d_n$ , we conclude that  $\mathfrak{A}$  refutes  $bd_n$ .

(3) $\Leftrightarrow$ (4) $\Leftrightarrow$ (8): This is well known; see Lemma 2.5 and [35, Lemma 2].

(5) $\Leftrightarrow$ (7): This is the Jankov–Fine Theorem.

(6) $\Leftrightarrow$ (7): This follows from Esakia duality.

(6) $\Rightarrow$ (8): This is obvious.

(8) $\Leftrightarrow$ (9): This follows from Esakia duality.

(4) $\Rightarrow$ (7): This is obvious since 1-1 and onto Esakia morphisms do not increase the depth. ⊣

REMARK 2.15. Theorem 2.14 can be extended to include the trivial algebra by letting  $bd_0 = \perp$ .

As an immediate consequence, we obtain:

COROLLARY 2.16. *The internal and external Krull dimensions of an **S4**-algebra coincide, and so Definitions 2.4 and 2.8 are equivalent.*

**§3. Modal Krull dimension of topological spaces.** As we pointed out in the introduction, it is inadequate to define the Krull dimension of a topological space  $X$  as the supremum of the lengths of finite chains in the specialization order of  $X$ . Section 2 suggests that a more adequate definition would result by working with the Krull dimension of  $\mathfrak{A}_X$ .

DEFINITION 3.1. Define the *modal Krull dimension*  $\text{mdim}(X)$  of a topological space  $X$  as the Krull dimension of  $\mathfrak{A}_X$ ; that is,  $\text{mdim}(X) = \text{kdim}(\mathfrak{A}_X)$ .

REMARK 3.2. It is immediate from Corollary 2.16 that the modal Krull dimension of a topological space  $X$  can be defined recursively as follows:

$$\begin{aligned} \text{mdim}(X) &= -1 && \text{if } X = \emptyset, \\ \text{mdim}(X) &\leq n && \text{if } \text{mdim}(D) \leq n - 1 \text{ for every nowhere dense subset } D \text{ of } X, \\ \text{mdim}(X) &= n && \text{if } \text{mdim}(X) \leq n \text{ and } \text{mdim}(X) \not\leq n - 1, \\ \text{mdim}(X) &= \infty && \text{if } \text{mdim}(X) \not\leq n \text{ for any } n = -1, 0, 1, 2, \dots \end{aligned}$$

LEMMA 3.3. *If  $Y$  is a subspace of  $X$ , then  $\text{mdim}(Y) \leq \text{mdim}(X)$ .*

PROOF. By Lemma 2.12(1),  $\text{mdim}(Y) = \text{kdim}(\mathfrak{A}_Y) \leq \text{kdim}(\mathfrak{A}_X) = \text{mdim}(X)$ . ⊣

LEMMA 3.4. *Let  $X$  be a topological space. Then  $\text{mdim}(X) \leq n$  iff for every closed nowhere dense subset  $D$  of  $X$  we have  $\text{mdim}(D) \leq n - 1$ .*

PROOF. Apply Lemma 2.12(2). ⊣

To obtain an analogue of Theorem 2.14 for modal Krull dimension, we require an analogue of the Jankov–Fine theorem for topological spaces. Let  $\mathfrak{F} = (W, R)$  be a finite rooted **S4**-frame and choose any enumeration of  $W = \{w_i \mid i < n\}$  in which  $w_0$  is a root of  $\mathfrak{F}$ . We recall [24] that the Jankov–Fine formula  $\chi_{\mathfrak{F}}$  associated with  $\mathfrak{F}$  is the conjunction of the following formulas:

1.  $p_0$ ,
2.  $\Box(p_0 \vee \dots \vee p_{n-1})$ ,

3.  $\Box(p_i \rightarrow \neg p_j)$  for distinct  $i, j < n$ ,
4.  $\Box(p_i \rightarrow \Diamond p_j)$  whenever  $w_i R w_j$ , and
5.  $\Box(p_i \rightarrow \neg \Diamond p_j)$  whenever  $\neg(w_i R w_j)$ .

The modal language is interpreted in a topological space  $X$  by interpreting it in the powerset algebra  $\mathfrak{A}_X$ . A modal formula  $\varphi$  is defined to be valid (resp. satisfiable) in  $X$  exactly when  $\varphi$  is valid (resp. satisfiable) in  $\mathfrak{A}_X$ . If  $\varphi$  is valid in  $X$ , then we write  $X \models \varphi$ . For a given valuation  $v$  and  $x \in X$ , we write  $x \models_v \varphi$ , or  $x \models \varphi$  for short, if  $\varphi$  is true at  $x$  under  $v$ .

An *interior map* between topological spaces  $X, Y$  is a continuous open map  $f : X \rightarrow Y$ . It is well known (see, e.g., [42, Section III.3]) that the following are equivalent:

- $f : X \rightarrow Y$  is interior,
- $f^{-1}(\mathbf{I}_Y A) = \mathbf{I}_X f^{-1}(A)$  for all  $A \subseteq Y$ ,
- $f^{-1}(\mathbf{C}_Y A) = \mathbf{C}_X f^{-1}(A)$  for all  $A \subseteq Y$ .

We call  $Y$  an *interior image* of  $X$  if there is an onto interior map  $f : X \rightarrow Y$ . The next lemma generalizes [24, Lemma 1] to topological spaces.

LEMMA 3.5. *Let  $X$  be a topological space. Then  $\chi_{\mathfrak{F}}$  is satisfiable in  $X$  iff  $\mathfrak{F}$  is an interior image of an open subspace of  $X$ .*

PROOF. First suppose that  $\mathfrak{F}$  is an interior image of an open subspace  $U$  of  $X$ , say via  $f : U \rightarrow \mathfrak{F}$ . Let  $p_i$  be interpreted as  $A_i := f^{-1}(w_i)$  when  $i < n$  and as  $A_i := \emptyset$  when  $i \geq n$ . Since  $A_0 = f^{-1}(w_0) \neq \emptyset$ , there is  $x \in U$  with  $x \models p_0$ . We show that  $x \models \chi_{\mathfrak{F}}$ . As  $A_0 \cup \dots \cup A_{n-1} = U$  and  $x \in U$ , we see that  $x \models \Box(p_0 \vee \dots \vee p_{n-1})$ . Suppose  $i \neq j$ . Because  $A_i \cap A_j = \emptyset$ , we see that  $x \models \Box(p_i \rightarrow \neg p_j)$ . Suppose  $w_i R w_j$ . Then  $w_i \in \Diamond_R \{w_j\}$ , so since  $f$  is interior,  $A_i = f^{-1}(w_i) \subseteq f^{-1} \Diamond_R \{w_j\} = \mathbf{C}_U f^{-1}(w_j) = \mathbf{C}_U A_j \subseteq \mathbf{C} A_j$ , where  $\mathbf{C}$  denotes closure in  $X$  and  $\mathbf{C}_U$  denotes closure in the subspace  $U$ . Therefore,  $x \models \Box(p_i \rightarrow \Diamond p_j)$ . Finally, suppose  $\neg(w_i R w_j)$ . Then  $\{w_i\} \cap \Diamond_R \{w_j\} = \emptyset$ . As  $f$  is interior, this yields  $f^{-1}(w_i) \cap \mathbf{C}_U f^{-1}(w_j) = \emptyset$ . Thus,  $A_i \cap \mathbf{C}_U A_j = \emptyset$ . But  $A_i \cap \mathbf{C}_U A_j = A_i \cap U \cap \mathbf{C} A_j = A_i \cap \mathbf{C} A_j$ . So  $A_i \cap \mathbf{C} A_j = \emptyset$ , which gives  $x \models \Box(p_i \rightarrow \neg \Diamond p_j)$ . Consequently,  $\chi_{\mathfrak{F}}$  is satisfiable at  $x$  in  $X$ .

Conversely suppose that  $\chi_{\mathfrak{F}}$  is satisfied at some  $x \in X$  by interpreting  $p_i$  as  $A_i \subseteq X$ . Set

$$U = \mathbf{I} \left( \bigcup_{i < n} A_i \right) \cap \bigcap_{0 \leq i \neq j < n} \mathbf{I}((X \setminus A_i) \cup (X \setminus A_j)) \\ \cap \bigcap_{w_i R w_j} \mathbf{I}((X \setminus A_i) \cup \mathbf{C} A_j) \cap \bigcap_{\neg(w_i R w_j)} \mathbf{I}((X \setminus A_i) \cup (X \setminus \mathbf{C} A_j)).$$

Then  $U$  is open and nonempty since  $x \in A_0 \cap U$ . Define  $f : U \rightarrow \mathfrak{F}$  by setting  $f(y) = w_i$  provided  $y \in A_i$  (for  $i < n$ ). To see that  $f$  is well defined, let  $y \in A_i \cap A_j$ . Then  $y \notin X \setminus \mathbf{C}(A_i \cap A_j) = \mathbf{I}((X \setminus A_i) \cup (X \setminus A_j))$ . Therefore, it follows from the definition of  $U$  that  $i = j$ , and so  $f$  is well defined.

To see that  $f$  is onto, since  $w_0$  is a root of  $\mathfrak{F}$ , we have  $w_0 R w_j$ , and so  $U \subseteq (X \setminus A_0) \cup \mathbf{C} A_j$  for all  $j < n$ . Recalling that  $x \in A_0 \cap U$ , we get  $x \in \mathbf{C} A_j$  for each  $j < n$ . As  $U$  is open and contains  $x$ , we have  $U \cap A_j \neq \emptyset$  for each  $j < n$ . Thus,  $f$  is onto.

Finally, to see that  $f$  is interior, it is sufficient to show that  $f^{-1}(\Diamond_R \{w_j\}) = \mathbf{C}_U f^{-1}(w_j)$  for each  $j < n$ . Suppose  $y \in f^{-1}(\Diamond_R \{w_j\})$ . Then  $f(y) R w_j$ . Assuming

$f(y) = w_i$ , we have  $y \in A_i$  and  $y \in (X \setminus A_i) \cup \mathbf{C}A_j$ , giving  $y \in \mathbf{C}A_j$ . So  $y \in U \cap \mathbf{C}A_j = \mathbf{C}_U A_j = \mathbf{C}_U f^{-1}(w_j)$ . Conversely, suppose  $y \notin f^{-1}(\diamond_R \{w_j\})$ . Then  $\neg(f(y) R w_j)$ . Assuming  $f(y) = w_i$ , we have  $y \in A_i$  and  $y \in (X \setminus A_i) \cup (X \setminus \mathbf{C}A_j)$ , yielding  $y \in X \setminus \mathbf{C}A_j$ . Thus,  $y \notin \mathbf{C}A_j$ , and hence  $y \notin \mathbf{C}_U A_j = \mathbf{C}_U f^{-1}(w_j)$ . Consequently,  $f$  is interior, and hence  $\mathfrak{F}$  is an interior image of an open subspace of  $X$ .  $\dashv$

The next theorem is an analogue of Theorem 2.14 for modal Krull dimension, and is the main result of this section.

**THEOREM 3.6.** *Let  $X \neq \emptyset$ ,  $n \geq 1$ , and  $\mathfrak{F}_{n+1}$  be the  $(n + 1)$ -element chain. The following are equivalent:*

1.  $\text{mdim}(X) \leq n - 1$ .
2. *There does not exist a sequence  $F_0, \dots, F_n$  of nonempty closed subsets of  $X$  such that  $F_0 = X$  and  $F_{i+1}$  is nowhere dense in  $F_i$  for each  $i \in \{0, \dots, n - 1\}$ .*
3.  $X \models \text{bd}_n$ .
4.  $X \models \neg\chi_{\mathfrak{F}_{n+1}}$ .
5.  $\mathfrak{F}_{n+1}$  is not an interior image of any open subspace of  $X$ .
6.  $\mathfrak{F}_{n+1}$  is not an interior image of  $X$ .

**PROOF.** (1) $\Leftrightarrow$ (2) $\Leftrightarrow$ (3) $\Leftrightarrow$ (4): This follows from the equivalence of Items (1), (2), (3), and (5) of Theorem 2.14, Definition 3.1, the correspondence between relativizations and subspaces, and the fact that  $X$  and  $\mathfrak{A}_X$  validate exactly the same modal formulas.

(4) $\Leftrightarrow$ (5): We have  $X \models \neg\chi_{\mathfrak{F}_{n+1}}$  iff  $\chi_{\mathfrak{F}_{n+1}}$  is not satisfiable in  $X$ . This, by Lemma 3.5, is equivalent to  $\mathfrak{F}_{n+1}$  not being an interior image of any open subspace of  $X$ .

(5) $\Rightarrow$ (6): This is obvious.

(6) $\Rightarrow$ (2): Suppose there is a sequence  $F_0, \dots, F_n$  of nonempty closed subsets of  $X$  such that  $F_0 = X$  and  $F_{i+1}$  is nowhere dense in  $F_i$  for each  $i \in \{0, \dots, n - 1\}$ . We show that  $\mathfrak{F}_{n+1}$  is an interior image of  $X$ . Let  $F_{n+1} = \emptyset$ . Define  $f : X \rightarrow W_{n+1}$  by  $f(x) = w_i$  if  $x \in F_i \setminus F_{i+1}$  for  $i \leq n$ . Clearly  $f$  is well-defined and onto since  $\{F_i \setminus F_{i+1} \mid i \leq n\}$  is a partition of  $X$ . Moreover,  $\mathbf{C}(F_i \setminus F_{i+1}) = F_i$  since  $F_i$  is closed in  $X$  and  $F_{i+1}$  is nowhere dense in  $F_i$  for  $i \leq n$ . Thus,

$$\begin{aligned} f^{-1}(\diamond_R \{w_i\}) &= f^{-1}(\{w_i, \dots, w_n\}) = \bigcup_{j=i}^n (F_j \setminus F_{j+1}) \\ &= F_i = \mathbf{C}(F_i \setminus F_{i+1}) = \mathbf{C}f^{-1}(w_i). \end{aligned}$$

Consequently,  $f$  is an onto interior map, and hence  $\mathfrak{F}_{n+1}$  is an interior image of  $X$ .  $\dashv$

Section 7 contains a comparison of modal Krull dimension with other well-known topological dimension functions. We conclude this section by calculating the modal Krull dimension of some well-known spaces.

**EXAMPLE 3.7.**

1. It follows from the celebrated McKinsey-Tarski theorem [37, 42] that every finite rooted **S4**-frame is an interior image of any dense-in-itself metric space. Let  $\mathbb{R}$ ,  $\mathcal{C}$ , and  $\mathbb{Q}$  denote the real line, the Cantor discontinuum, and the rational line, respectively. It follows from Theorem 3.6 that each of  $\mathbb{R}$ ,  $\mathcal{C}$ ,  $\mathbb{Q}$  has infinite modal Krull dimension.
2. We view ordinals as topological spaces equipped with the interval topology induced by the well order. Let  $n \geq 1$ . It is well known that the  $n$ -element chain

- is an interior image of the ordinal  $\omega^n$ , and that the  $(n + 1)$ -element chain is not an interior image of  $\omega^n$ . By Theorem 3.6,  $\text{mdim}(\omega^n) = n - 1$ .
3. A reasoning similar to (2) yields that  $\text{mdim}(\omega^n + 1) = n$  and  $\text{mdim}(\omega^\omega + 1) = \infty$ . Since these ordinals are compact, and hence Stone spaces, we obtain the examples alluded to in the introduction.
  4. Let  $X$  be a nonempty Alexandroff space and let  $n \geq 1$ . By Theorem 3.6,  $\text{mdim}(X) \leq n - 1$  iff  $X \models \text{bd}_n$ . This together with the finite model property of  $\mathbf{S4}_n$  yields that  $\mathbf{S4}_n$  is the logic of the class of all nonempty Alexandroff spaces of modal Krull dimension  $\leq n - 1$ . Since every finite space is Alexandroff,  $\mathbf{S4}_n$  is also the logic of the class of all nonempty finite spaces of modal Krull dimension  $\leq n - 1$ .

For  $T_1$ -spaces there is an alternate description of modal Krull dimension, which is based on an appropriate generalization of the concept of a nodec space. This will be discussed in the next section.

**§4.  $n$ -discrete algebras,  $n$ -nodec spaces, and  $n$ -Zeman formulas.** In this section we generalize the notion of a discrete  $\mathbf{S4}$ -algebra to that of an  $n$ -discrete  $\mathbf{S4}$ -algebra. The topological counterpart of this generalization yields a generalization of the concept of a nodec space. As was shown in [3], nodec spaces are modally definable by the Zeman formula. We introduce  $n$ -Zeman formulas and show that they define  $n$ -discrete  $\mathbf{S4}$ -algebras and  $n$ -nodec spaces. We prove that a  $T_1$ -space  $X$  is  $n$ -nodec iff  $\text{mdim}(X) \leq n$ . From this we derive that there are infinitely many modal logics incomplete with respect to any class of  $T_1$ -spaces.

DEFINITION 4.1. Let  $\mathfrak{A}$  be a nontrivial  $\mathbf{S4}$ -algebra.

1. Call  $\mathfrak{A}$  *0-discrete* if  $\mathfrak{A}$  is discrete.
2. For  $n \geq 1$ , call  $\mathfrak{A}$   *$n$ -discrete* if  $\mathfrak{A}_a$  is  $(n - 1)$ -discrete for each nowhere dense  $a \in \mathfrak{A}$ .

REMARK 4.2. This definition can be extended to all  $\mathbf{S4}$ -algebras by letting the trivial  $\mathbf{S4}$ -algebra to be  $(-1)$ -discrete.

In order to axiomatize  $n$ -discrete  $\mathbf{S4}$ -algebras, we generalize the Zeman formula

$$\text{zem} = \Box \Diamond \Box p \rightarrow (p \rightarrow \Box p)$$

as follows.

DEFINITION 4.3. Set  $\text{bd}_0 = \perp$ , and for  $n \geq 0$ , define

$$\text{zem}_n = p_{n+1} \rightarrow \Box(\text{bd}_n \vee p_{n+1}).$$

We call  $\text{zem}_n$  the  *$n$ -Zeman formula*, and we call

$$\mathbf{S4.Z}_n := \mathbf{S4} + \text{zem}_n$$

the  *$n$ -Zeman logic*.

REMARK 4.4.

1. An easy induction shows that  $\text{bd}_n$  and  $\text{zem}_n$  are Sahlqvist formulas (see, e.g., [2, Definition 3.1]). Therefore,  $\mathbf{S4}_n$  and  $\mathbf{S4.Z}_n$  are Sahlqvist logics. Thus,  $\mathbf{S4}_n$  and  $\mathbf{S4.Z}_n$  are canonical, and hence Kripke complete (see, e.g., [10, Section 10.3] or [6, Sections 3.6 and 5.6]).

2. It is easy to see that  $\text{zem}_0$  is equivalent to  $p \rightarrow \Box p$ , and hence  $\mathbf{S4.Z}_0$  is the logic of (nontrivial) discrete  $\mathbf{S4}$ -algebras. We will see shortly that  $\text{zem}_1$  is equivalent to  $\text{zem}$ , and hence  $\mathbf{S4.Z}_1$  is the Zeman logic  $\mathbf{S4.Z} := \mathbf{S4} + \text{zem}$ .

**THEOREM 4.5.** *Let  $\mathfrak{A}$  be a nontrivial  $\mathbf{S4}$ -algebra and  $n \geq 0$ . The following are equivalent:*

1.  $\mathfrak{A}$  is  $n$ -discrete.
2.  $\mathfrak{A} \models \text{zem}_n$ .
3. There is no chain  $w_{n+1} R w_n \vec{R} w_{n-1} \vec{R} \cdots \vec{R} w_1 \vec{R} w_0$  in  $\mathfrak{A}_*$  satisfying  $w_{n+1} \neq w_n$ .

**PROOF.** (1) $\Rightarrow$ (3): Suppose that  $\mathfrak{A}$  is  $n$ -discrete. If there is a chain

$$w_{n+1} R w_n \vec{R} w_{n-1} \vec{R} \cdots \vec{R} w_1 \vec{R} w_0$$

in  $\mathfrak{A}_*$  satisfying  $w_{n+1} \neq w_n$ , then we build inductively a decreasing sequence of clopen  $R$ -downsets  $A_0, \dots, A_n$  of  $\mathfrak{A}_*$  such that  $w_i \notin A_{i+1}$ ,  $w_{i+1} \in A_{i+1}$ , and  $A_{i+1} \cap \max_R(A_i) = \emptyset$  for  $0 \leq i \leq n - 1$ . Let  $A_0 = W$ . Suppose  $A_i$  is already built. Since  $w_{i+1} \vec{R} w_i$ , we have  $w_{i+1} \notin R[\max_R(A_i) \cup \{w_i\}]$ . Now  $\max_R(A_i) \cup \{w_i\}$  is closed, and it follows that  $R[\max_R(A_i) \cup \{w_i\}]$  is closed as well. So  $W \setminus R[\max_R(A_i) \cup \{w_i\}]$  is open and contains  $w_{i+1}$ . Therefore, there is a clopen  $R$ -downset  $A_{i+1}$  such that  $A_{i+1} \subseteq A_i$ ,  $w_{i+1} \in A_{i+1}$ , and  $A_{i+1} \cap R[\max_R(A_i) \cup \{w_i\}] = \emptyset$ . Let  $a_0, \dots, a_n \in \mathfrak{A}$  be such that  $\beta(a_i) = A_i$  for  $i \leq n$ . Since  $A_{i+1} \cap \max_R(A_i) = \emptyset$ , Lemma 2.3 yields that  $a_{i+1}$  is nowhere dense in  $\mathfrak{A}_{a_i}$  for  $i < n$ . Because  $\mathfrak{A}$  is  $n$ -discrete,  $\mathfrak{A}_{a_i}$  is  $(n - i)$ -discrete for each  $i \leq n$ . So  $\mathfrak{A}_{a_n}$  is 0-discrete, and hence discrete. We show this is a contradiction. Since  $w_n \neq w_{n+1}$ , there is clopen  $A_{n+1}$  of  $\mathfrak{A}_*$  such that  $w_n \notin A_{n+1}$  and  $w_{n+1} \in A_{n+1}$ . Set  $B = A_n \setminus A_{n+1}$ . Then  $w_{n+1} R w_n \in B$ , so  $w_{n+1} \in \diamond_R B \setminus B$ . Let  $b \in \mathfrak{A}$  be such that  $\beta(b) = B$ . Then  $b \in \mathfrak{A}_{a_n}$ , and since  $\diamond_R B \neq B$ , we have  $\diamond b \neq b$  in  $\mathfrak{A}_{a_n}$ , contradicting that  $\mathfrak{A}_{a_n}$  is discrete.

(3) $\Rightarrow$ (1): Suppose that  $\mathfrak{A}$  is not  $n$ -discrete. Then there is a sequence of closed elements  $a_0, \dots, a_n \in \mathfrak{A}$  such that  $a_0 = 1$ ,  $a_{i+1}$  is nowhere dense in  $\mathfrak{A}_{a_i}$  for  $i < n$ , and  $\mathfrak{A}_{a_n}$  is not discrete. Let  $A_i := \beta(a_i)$  for  $i \leq n$ . Clearly each  $A_i$  is a clopen  $R$ -downset, and Lemma 2.3 gives  $A_{i+1} \cap \max_R(A_i) = \emptyset$  for  $i < n$ . As  $\mathfrak{A}_{a_n}$  is not discrete, there is  $a \in \mathfrak{A}_{a_n}$  such that  $a \neq \diamond a$ . Therefore, there is  $w \in \diamond_R \beta(a) \setminus \beta(a)$ . Thus, there is  $v \in \beta(a)$  such that  $w R v$ . Clearly  $w, v$  are distinct. We build  $w_0, \dots, w_{n+1}$  as follows. Set  $w_{n+1} := w$  and  $w_n := v$ . As  $a \leq a_n$ , we see that  $w_n \in A_n$ . Suppose  $w_i$  has already been chosen in  $A_i$  for  $1 \leq i \leq n$ . Since  $A_i \subseteq A_{i-1}$ , there is  $w_{i-1} \in \max_R(A_{i-1})$  such that  $w_i R w_{i-1}$ . As  $a_i$  is nowhere dense in  $\mathfrak{A}_{a_{i-1}}$ , we have  $w_i \notin \max_R(A_{i-1})$ , so  $w_i \vec{R} w_{i-1}$ . Therefore,

$$w_{n+1} R w_n \vec{R} w_{n-1} \vec{R} \cdots \vec{R} w_1 \vec{R} w_0$$

is a chain in  $\mathfrak{A}_*$  satisfying  $w_{n+1} \neq w_n$ .

(2) $\Leftrightarrow$ (3): This follows directly from standard Sahlqvist theory (see, e.g., [6, Sections 3.6 and 5.6]). ⊣

**THEOREM 4.6.**

1.  $\mathbf{S4}_{n+1} \subset \mathbf{S4.Z}_n$  for  $n \geq 0$ .
2.  $\mathbf{S4.Z}_n \subset \mathbf{S4}_n$  for  $n \geq 1$ .
3.  $\mathbf{S4} = \bigcap_{n \geq 1} \mathbf{S4}_n = \bigcap_{n \geq 0} \mathbf{S4.Z}_n$ .
4.  $\mathbf{S4.Z}_n$  is canonical for  $n \geq 0$ .
5.  $\mathbf{S4.Z}_n$  has the finite model property for  $n \geq 0$ .
6.  $\mathbf{S4.Z}_1 = \mathbf{S4.Z}$ .

PROOF. (1) Suppose  $\mathfrak{A} \models \mathbf{S4.Z}_n$ . It follows from Theorem 4.5 that  $\text{depth}(\mathfrak{A}_*) \leq n + 1$ . Therefore, by Theorem 2.14,  $\mathfrak{A} \models \mathbf{S4}_{n+1}$ . Thus,  $\mathbf{S4}_{n+1} \subseteq \mathbf{S4.Z}_n$ . To see that the inclusion is proper, consider the finite  $\mathbf{S4}$ -frame  $\mathfrak{F}_2^n$  depicted in Figure 2. Since  $\text{depth}(\mathfrak{F}_2^n) = n + 1$ , we see that  $\mathfrak{F}_2^n \models \mathbf{S4}_{n+1}$ . On the other hand, as

$$r_2 R r_1 \vec{R} w_{n-1} \vec{R} \cdots \vec{R} w_1 \vec{R} w_0$$

and  $r_2 \neq r_1$ , Theorem 4.5 implies  $\mathfrak{F}_2^n \not\models \mathbf{S4.Z}_n$ .

(2) Suppose  $\mathfrak{A} \models \mathbf{S4}_n$ . Then  $\text{depth}(\mathfrak{A}_*) \leq n$  by Theorem 2.14. Therefore, there is no chain  $w_n \vec{R} w_{n-1} \vec{R} \cdots \vec{R} w_1 \vec{R} w_0$  in  $\mathfrak{A}_*$ . Thus, Theorem 4.5 yields that  $\mathfrak{A} \models \mathbf{S4.Z}_n$ , and hence  $\mathbf{S4.Z}_n \subseteq \mathbf{S4}_n$ . To see the inclusion is proper, consider  $\mathfrak{F}_1^n$  depicted in Figure 2. Since  $\text{depth}(\mathfrak{F}_1^n) = n + 1$ , we see that  $\mathfrak{F}_1^n \not\models \mathbf{S4}_n$ . On the other hand, it follows from Theorem 4.5 that  $\mathfrak{F}_1^n \models \mathbf{S4.Z}_n$ .

(3) Since  $\mathbf{S4}$  has the finite model property, it follows that  $\mathbf{S4} = \bigcap_{n \geq 1} \mathbf{S4}_n$ . Thus, by (2),

$$\mathbf{S4} = \bigcap_{n \geq 1} \mathbf{S4}_n \supseteq \bigcap_{n \geq 1} \mathbf{S4.Z}_n = \bigcap_{n \geq 0} \mathbf{S4.Z}_n \supseteq \mathbf{S4}.$$

(4) Since  $\mathbf{S4.Z}_n$  is a Sahlqvist logic, it is canonical (see, e.g., [6, 10]).

(5) Follows from (1) since every normal extension of  $\mathbf{S4}_{n+1}$  (for  $n \geq 0$ ) has the finite model property.

(6) By (5) and Theorem 4.5,  $\mathbf{S4.Z}_1$  is the logic of finite  $\mathbf{S4}$ -frames in which there is no chain  $w_2 R w_1 \vec{R} w_0$  satisfying  $w_2 \neq w_1$ . By [43, Theorem II.7.5], the same is true of  $\mathbf{S4.Z}$ . Thus,  $\mathbf{S4.Z}_1 = \mathbf{S4.Z}$ .  $\dashv$

As we just saw,  $\mathbf{S4.Z}_1 = \mathbf{S4.Z}$ . By [3, Theorem 4.6],  $\mathbf{S4.Z}$  is the logic of nodec spaces, where we recall that a space is *nodec* if every nowhere dense set is closed. Since a space is nodec iff every nowhere dense set is closed and discrete (see, e.g., [14]), the next definition generalizes the notion of a nodec space.

DEFINITION 4.7. We call a nonempty topological space  $X$  *n-nodec* provided  $\mathfrak{A}_X$  is *n-discrete*.

REMARK 4.8. Suppose  $X$  is nonempty.

1.  $X$  is 0-nodec iff  $X$  is discrete.
2.  $X$  is 1-nodec iff  $X$  is nodec.
3. For  $n \geq 1$ ,  $X$  is  $n$ -nodec iff every nowhere dense subset of  $X$  is  $(n - 1)$ -nodec.
4.  $X$  is  $n$ -nodec iff  $X \models \text{zem}_n$ .

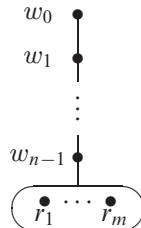

FIGURE 2. The  $\mathbf{S4}_{n+1}$ -frame  $\mathfrak{F}_m^n$ .



**THEOREM 4.9.** *Let  $X$  be a nonempty  $T_1$ -space and  $n \in \omega$ . Then  $\text{mdim}(X) \leq n$  iff  $X$  is  $n$ -nodec.*

**PROOF.** By induction on  $n$ . First suppose  $n = 0$ . If  $X$  is discrete, then the only nowhere dense subset of  $X$  is  $\emptyset$ . Therefore,  $\text{mdim}(X) \leq 0$ . Conversely, if  $X$  is not discrete, then there is  $x \in X$  such that  $\{x\}$  is not open, so  $\mathbf{I}\{x\} = \emptyset$ . Since  $X$  is  $T_1$ , we see that  $\mathbf{IC}\{x\} = \mathbf{I}\{x\} = \emptyset$ , so  $\{x\}$  is nowhere dense. Thus,  $\text{mdim}(X) > 0$ .

Next suppose that for every  $T_1$ -space  $Y$ , we have  $Y$  is  $n$ -nodec iff  $\text{mdim}(Y) \leq n$ . We show that  $X$  is  $(n + 1)$ -nodec iff  $\text{mdim}(X) \leq n + 1$ . We have  $\text{mdim}(X) \leq n + 1$  iff  $\text{mdim}(Y) \leq n$  for every nowhere dense subspace  $Y$  of  $X$ . Since a subspace of a  $T_1$ -space is a  $T_1$ -space, by inductive hypothesis, this is equivalent to every nowhere dense subspace  $Y$  of  $X$  being  $n$ -nodec. But this is equivalent to  $X$  being  $(n + 1)$ -nodec.  $\dashv$

**COROLLARY 4.10.** *For  $n \geq 0$ , the interval  $[\mathbf{S4}_{n+1}, \mathbf{S4.Z}_n]$  is infinite and no logic in  $[\mathbf{S4}_{n+1}, \mathbf{S4.Z}_n]$  is the logic of any class of  $T_1$ -spaces.*

**PROOF.** To see that  $(\mathbf{S4}_{n+1}, \mathbf{S4.Z}_n)$  is infinite, for  $m \geq 2$ , let  $L_m$  be the logic of  $\mathfrak{F}_m^n$  depicted in Figure 2. Since  $\mathfrak{F}_m^n$  is a p-morphic image of  $\mathfrak{F}_{m+1}^n$  and  $\mathfrak{F}_{m+1}^n$  is not a p-morphic image of a generated subframe of  $\mathfrak{F}_m^n$ , we have  $\neg\chi_{\mathfrak{F}_{m+1}^n} \in L_m \setminus L_{m+1}$ , and hence

$$\mathbf{S4}_{n+1} \subset \cdots \subset L_{m+1} \cap \mathbf{S4.Z}_n \subset L_m \cap \mathbf{S4.Z}_n \subset \cdots \subset L_2 \cap \mathbf{S4.Z}_n \subset \mathbf{S4.Z}_n.$$

Next suppose  $L \in (\mathbf{S4}_{n+1}, \mathbf{S4.Z}_n)$  and  $\mathcal{K}$  is a class of  $T_1$ -spaces. If  $L$  is the logic of  $\mathcal{K}$ , then for each  $X \in \mathcal{K}$ , we have  $X \models L$ . Therefore, since  $\mathbf{S4}_{n+1} \subseteq L$ , we have  $X \models \text{bd}_{n+1}$ . By Theorem 3.6,  $\text{mdim}(X) \leq n$ . As  $X$  is  $T_1$ , by Theorem 4.9,  $X$  is  $n$ -nodec. By Remark 4.8,  $X \models \text{zem}_n$ . Thus,  $\mathbf{S4.Z}_n \subseteq L$ , a contradiction. Consequently,  $L$  is not the logic of any class of  $T_1$ -spaces.  $\dashv$

**REMARK 4.11.** By Segerberg’s Theorem, each  $L \in (\mathbf{S4}_{n+1}, \mathbf{S4.Z}_n)$  is Kripke complete, hence topologically complete. However, the completeness is with respect to spaces that are not  $T_1$ .

**§5. Topological completeness of  $\mathbf{S4.Z}_n$ .** The McKinsey–Tarski theorem not only shows that  $\mathbf{S4}$  is the basic modal logic associated with topological spaces, but also that  $\mathbf{S4}$  is the logic of ‘nice’ spaces; i.e., any dense-in-itself metric space. Analogously,  $\mathbf{S4}_{n+1}$  is the basic logic of topological spaces of modal Krull dimension  $n \geq 0$ . However, Corollary 4.10 shows that it cannot be the logic of ‘nice’ spaces. In fact, it follows from Theorem 4.9 that  $\mathbf{S4.Z}_n$  is the basic logic of  $T_1$ -spaces of modal Krull dimension  $n$ . Thus, it is natural to seek a version of the McKinsey–Tarski theorem for  $\mathbf{S4.Z}_n$  where  $n \geq 0$ .

Since  $\mathbf{S4.Z}_0 \vdash p \rightarrow \Box p$ , it is clear that  $\mathbf{S4.Z}_0$  is the logic of any nonempty discrete space. On the other hand, it follows from the result of [5] mentioned in the introduction that  $\mathbf{S4.Z}_n$  is not the logic of any metric space for  $n \geq 1$ . In fact, if the logic  $L$  of a metric space is contained in the logic  $M$  of the two-element cluster, then since  $\mathbf{S4.1} \not\subseteq M$ , we must have  $L = \mathbf{S4}$ .

The goal of this section is to construct for each  $n \geq 1$  a countable dense-in-itself  $\omega$ -resolvable Tychonoff space  $Z_n$  of modal Krull dimension  $n$  such that  $\mathbf{S4.Z}_n$  is the logic of  $Z_n$ . This construction is technically the most challenging part of the paper. Since finite Tychonoff spaces are discrete,  $\mathbf{S4.Z}_n$  does not have the finite

model property with respect to Tychonoff spaces for  $n \geq 1$ . On the other hand, because  $Z_n$  is countable, we obtain that  $\mathbf{S4.Z}_n$  has the countable model property with respect to Tychonoff spaces. Since countable Tychonoff spaces are normal (see, e.g., [19, Theorem 1.5.17]), we obtain that  $\mathbf{S4.Z}_n$  has the countable model property with respect to normal spaces.

Our technique is to identify a single frame  $\mathcal{Q}_{n+1}$  whose logic is  $\mathbf{S4.Z}_n$  and utilize  $\mathcal{Q}_{n+1}$  to guide the construction of  $Z_n$  as follows. The depth of  $\mathcal{Q}_{n+1}$  indicates the necessary modal Krull dimension of  $Z_n$ . Thus, since  $Z_n$  is Tychonoff and hence  $T_1$ , Theorem 4.9 yields that  $\mathbf{S4.Z}_n$  is sound with respect to  $Z_n$ . In addition, we construct  $Z_n$  so that  $\mathcal{Q}_{n+1}$  is an interior image of  $Z_n$ . Consequently,  $\mathbf{S4.Z}_n$  is complete with respect to  $Z_n$ . Since there is no restriction on the cluster size of  $\mathcal{Q}_{n+1}$  (except at the root), for such an interior map to exist,  $Z_n$  needs to be  $\omega$ -resolvable. Also, since there is no restriction on the branching in  $\mathcal{Q}_{n+1}$  (except at the maximal points), we build  $Z_n$  step-by-step, utilizing the construction of adjunction spaces (for the simplest case see Figure 4).

The basic building block for the construction is a countable dense-in-itself  $\omega$ -resolvable Tychonoff nodec space  $Y$  such that the remainder  $Y^* = \beta Y \setminus Y$  contains a subspace homeomorphic to  $\beta\omega$  which consists entirely of remote points of  $Y$ . In Section 5.1 we explain why such a building block  $Y$  exists, in Section 5.2 we build the spaces  $Z_n$  from  $Y$ , and in Section 5.3 we prove that  $\mathbf{S4.Z}_n$  is the logic of  $Z_n$ .

**5.1. The basic building block.** Let  $X$  be a topological space. We recall (see Juhász [32, 33]) that a  $\pi$ -base of  $X$  is a collection  $\mathcal{B}$  of nonempty open subsets of  $X$  such that every nonempty open subset of  $X$  contains a member of  $\mathcal{B}$ . The  $\pi$ -weight  $\pi(X)$  of  $X$  is the smallest cardinality of such a family. We will be interested in Tychonoff spaces of countable  $\pi$ -weight.

For a compact Hausdorff space  $X$ , let  $EX$  be the *Gleason cover* of  $X$  [26, 41]. It is well known that  $EX$  is constructed as the Stone space of the Boolean algebra of regular open subsets of  $X$ , and hence  $EX$  is an extremally disconnected compact Hausdorff space, where we recall that a space is *extremally disconnected* if the closure of each open set is open.

If  $\nabla \in EX$ , then  $\bigcap \{C_X(U) \mid U \in \nabla\}$  is a singleton of  $X$ , which we denote by  $p_X(\nabla)$ . This defines a map  $p_X : EX \rightarrow X$ . It is well known that  $p_X$  is an *irreducible map*; that is,  $p_X$  is an onto continuous map such that for every proper closed subset  $F$  of  $EX$ , the image  $p_X(F)$  is a proper closed subset of  $X$ . Since  $p_X$  is evidently closed, this yields that  $F \subseteq EX$  is nowhere dense iff  $p_X(F) \subseteq X$  is nowhere dense, and that  $\pi(X) = \pi(EX)$ .

Let  $Z$  be a subspace of  $X$ . A point  $x \in X \setminus Z$  is *remote* from  $Z$  provided  $x \notin C_X(D)$  for every nowhere dense subset  $D$  of  $Z$ . Observe that if  $x$  is remote from  $Z$ , then  $x$  is remote from every subspace of  $Z$ . The following simple lemma was used in [16, 39] for constructing various examples.

**LEMMA 5.1.** *For a  $T_1$ -space  $X$ , if every  $x \in X$  is remote from  $X \setminus \{x\}$ , then  $X$  is nodec.*

**PROOF.** Let  $D$  be a nowhere dense subset of  $X$  and  $x \notin D$ . Since  $X$  is a  $T_1$ -space,  $D$  is a nowhere dense subset of  $X \setminus \{x\}$ . Therefore, as  $x$  is remote from  $X \setminus \{x\}$ , we see that  $x \notin C_X(D)$ . Thus,  $X$  is nodec.  $\dashv$

Suppose  $X$  is a Tychonoff space. A *remote point* of  $X$  is a point  $p \in \beta X \setminus X$  that is remote from  $X$ . In the context of Čech-Stone compactifications, remote points are very well studied in the literature. In particular, we have:

**THEOREM 5.2.** [9, 13] *If  $X$  is a nonpseudocompact Tychonoff space with countable  $\pi$ -weight, then the remainder  $X^* := \beta X \setminus X$  contains a point that is remote from  $X$ .*

Here we recall that a Tychonoff space  $X$  is *pseudocompact* if every continuous real-valued function on  $X$  is bounded. This result was generalized to products of such spaces in [15].

Let  $\mathbb{I}$  be the closed unit interval and let  $E\mathbb{I}$  be the Gleason cover of  $\mathbb{I}$ . For  $t \in \mathbb{I}$ , let  $X = E\mathbb{I} \setminus p_{\mathbb{I}}^{-1}(\{t\})$ . Since  $X$  is a dense subspace of  $E\mathbb{I}$ , it is  $C^*$ -embedded in  $E\mathbb{I}$  (see, e.g., [46, Proposition 10.47]), meaning that every bounded continuous real-valued function on  $X$  extends to  $E\mathbb{I}$ . Therefore, by [46, Theorem 1.46],  $\beta X = E\mathbb{I}$ . It is also clear that  $X$  is a nonpseudocompact Tychonoff space with countable  $\pi$ -weight. Thus, by Theorem 5.2, there is a point  $x_t \in p_{\mathbb{I}}^{-1}(\{t\})$  that is remote from  $X$ .

Let  $D$  be any countable dense subset of  $\mathbb{I}$  (e.g.,  $D = \mathbb{I} \cap \mathbb{Q}$ ). We set

$$Y := \{x_t \mid t \in D\}.$$

**LEMMA 5.3** ([16, 39]).  *$Y$  is a countable dense-in-itself extremally disconnected  $\kappa$ -resolvable nodec space that is of countable  $\pi$ -weight.*

Here we recall (see, e.g., [17]) that a partition  $\mathcal{P}$  of a space  $X$  is *dense* if each  $D \in \mathcal{P}$  is dense in  $X$ , and that  $X$  is  $\kappa$ -*resolvable* if it has a dense partition of size  $\kappa$ . We now isolate the crucial property of  $Y$  that makes our construction in Section 5.2 work.

**PROPOSITION 5.4.**  *$Y$  has a compact set of remote points that is homeomorphic to  $\beta\omega$ .*

**PROOF.** Since  $Y$  is countable, we can pick a nonempty closed  $G_\delta$ -subset  $S$  of  $\beta Y$  such that  $Y \cap S = \emptyset$ . Put  $T = \beta Y \setminus S$ . By [46, Theorem 1.49],  $\beta T = \beta Y$  and  $T^* = S$ . By [13, Theorem 11.1], we can choose a countably infinite discrete set  $D$  consisting entirely of remote points of  $T$  every limit point of which is also a remote point of  $T$ . Observe that every point from  $D$  is remote from  $Y$  since  $Y$  is a subspace of  $T$ . We show that  $D$  is  $C^*$ -embedded in  $\beta Y$  by utilizing a technique of [40]. Since  $D \subseteq T^* = S$  and  $S$  is closed,  $\mathbf{C}D \subseteq S$ . Because  $Y \subseteq \beta Y \setminus S$ , we see that  $\mathbf{C}(D) \cap Y \subseteq \mathbf{C}(D) \setminus S = \emptyset$ . Therefore,  $D$  is closed in the subspace  $D \cup Y$ , which is normal since it is countable. By the Tietze Extension Theorem (see, e.g., [19, Theorem 2.1.8]),  $D$  is  $C^*$ -embedded in  $D \cup Y$ , and so  $D$  is  $C^*$ -embedded in  $\beta Y$ . This, by [46, Theorem 1.46], yields that  $\mathbf{C}(D) = \beta D$ , and hence  $Y$  has a compact set of remote points that is homeomorphic to  $\beta\omega$ . ⊔

**5.2. The spaces  $Z_n$ .** Let  $\mathfrak{F} = (W, R)$  be a rooted **S4**-frame. We call  $\mathfrak{F}$  a *tree* if  $R$  is a partial order and  $(\forall w, u, v \in W)(u R w \text{ and } v R w \Rightarrow u R v \text{ or } v R u)$ . We will always denote the root of a tree  $\mathfrak{F}$  by  $r$ , the  $R$ -maximal points of  $\mathfrak{F}$  by  $\max(\mathfrak{F})$ , and call  $v$  a *child* of  $w$  provided  $w \bar{R} v$  and from  $w R u R v$  it follows that  $w = u$  or  $u = v$ . For  $n \geq 1$ , let  $\mathfrak{T}_n$  denote the tree of depth  $n$  in which all non- $R$ -maximal points have  $\omega$  children.

Define an equivalence relation on an **S4**-frame  $\mathfrak{F} = (W, R)$  by setting

$$w \sim v \text{ iff } w R v \text{ and } v R w.$$

As is customary, we call equivalence classes of  $\sim$  clusters. The skeleton of  $\mathfrak{F}$  is the partially ordered **S4**-frame obtained by modding out the clusters of  $\mathfrak{F}$ . We call a cluster in  $\mathfrak{F}$  *trivial* if it is a singleton, and *proper* otherwise. We call  $\mathfrak{F}$  a *quasi-tree* if the skeleton of  $\mathfrak{F}$  is a tree. A cluster of a quasi-tree  $\mathfrak{F}$  is *maximal* if all its points are  $R$ -maximal, and it is the *root cluster* if it contains a root of  $\mathfrak{F}$ .

Let  $\mathcal{P}$  be a partition of a space  $X$ . We call  $\mathcal{P}$  *clopen* provided each  $A \in \mathcal{P}$  is clopen in  $X$ . For a cardinal  $\kappa$ , we consider the  $\kappa$ -fork depicted in Figure 3.

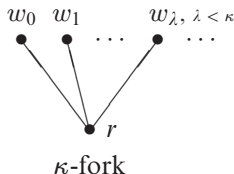

FIGURE 3. The  $\kappa$ -fork.

LEMMA 5.5. *The  $\kappa$ -fork is an interior image of a space  $X$  iff there are a closed nowhere dense subset  $N$  of  $X$  and a clopen partition  $\mathcal{P} = \{A_\lambda \mid \lambda < \kappa\}$  of the subspace  $X \setminus N$  such that  $\mathbf{C}A = A \cup N$  for each  $A \in \mathcal{P}$ .*

PROOF. Let  $\mathfrak{F} = (W, R)$  be the  $\kappa$ -fork. First suppose that  $f : X \rightarrow W$  is an onto interior map. Let  $N = f^{-1}(r)$  and  $A_\lambda = f^{-1}(w_\lambda)$ . Then

$$\mathbf{C}N = \mathbf{C}f^{-1}(r) = f^{-1}(\diamond_R\{r\}) = f^{-1}(r) = N$$

and

$$\mathbf{I}N = \mathbf{I}N = \mathbf{I}f^{-1}(r) = f^{-1}(\square_R\{r\}) = f^{-1}(\emptyset) = \emptyset.$$

Therefore,  $N$  is closed and nowhere dense in  $X$ . Clearly  $\mathcal{P} = \{A_\lambda \mid \lambda < \kappa\}$  is a partition of  $X \setminus N$ . Moreover, since each  $\{w_\lambda\}$  is simultaneously an  $R$ -upset and an  $R$ -downset in the subframe  $W \setminus \{r\}$ , each  $A_\lambda$  is clopen in  $X \setminus N$ . Finally,

$$\mathbf{C}A_\lambda = \mathbf{C}f^{-1}(w_\lambda) = f^{-1}(\diamond_R\{w_\lambda\}) = f^{-1}(\{w_\lambda, r\}) = A_\lambda \cup N.$$

Next suppose that there are a closed nowhere dense subset  $N$  of  $X$  and a clopen partition  $\mathcal{P} = \{A_\lambda \mid \lambda < \kappa\}$  of the subspace  $X \setminus N$  such that  $\mathbf{C}A = A \cup N$  for each  $A \in \mathcal{P}$ . Define  $f : X \rightarrow W$  by setting

$$f(x) = \begin{cases} r & \text{if } x \in N, \\ w_\lambda & \text{if } x \in A_\lambda. \end{cases}$$

It is clear that  $f$  is a well-defined onto map. Moreover,

$$f^{-1}(\diamond_R\{r\}) = f^{-1}(r) = N = \mathbf{C}N = \mathbf{C}f^{-1}(r)$$

and

$$f^{-1}(\diamond_R\{w_\lambda\}) = f^{-1}(\{w_\lambda, r\}) = A_\lambda \cup N = \mathbf{C}A_\lambda = \mathbf{C}f^{-1}(w_\lambda).$$

Thus,  $f$  is interior. ⊣

We assume the reader is familiar with the construction of attaching spaces or adjunction space (see, e.g., [28, pp. 12–14] or [47, pp. 65–66]). Given an indexed family of spaces  $X_i$  and subspaces  $Y_i \subseteq X_i$ , along with continuous maps  $f_i : Y_i \rightarrow Z$ , one can form an *adjunction space* which is a quotient of the topological sum  $\bigoplus_{i \in I} X_i$  in which the only nontrivial equivalence classes are

$$\{(y_i, y_j) \mid i, j \in I, y_i \in Y_i, y_j \in Y_j, f_i(y_i) = f_j(y_j)\}.$$

When  $Z$  is a singleton, the adjunction space is often referred to as the *wedge sum*.

Given an equivalence relation  $\equiv$  on a set  $X$ , let  $[x]$  be the equivalence class of  $x \in X$ . We call  $U \subseteq X$  *saturated* provided that  $x \in U$  implies  $[x] \subseteq U$ . Recall that open (resp. closed) sets in a quotient space  $X/\equiv$  correspond to saturated open (resp. closed) sets in  $X$ .

Using  $Y$  we recursively build the family of spaces  $\{Z_n \mid n \geq 1\}$  such that each  $Z_n$  is a subspace of  $Z_{n+1}$  and there is an onto interior mapping  $\alpha_n : Z_n \rightarrow \mathfrak{T}_{n+1}$ .

**BASE CASE ( $n = 1$ ):** Let  $\{Y_n \mid n \in \omega\}$  be a pairwise disjoint family of spaces such that there is a homeomorphism  $h_n : Y \rightarrow Y_n$  for each  $n \in \omega$ . Fix  $y \in Y$  and set  $y_n = h_n(y)$ . Let  $Z_1$  be the wedge sum of  $\{(Y_n, y_n) \mid n \in \omega\}$ . We identify each  $Y_n \setminus \{y_n\}$  with its image in  $Z_1$  and refer to the point  $\{y_n \mid n \in \omega\}$  in  $Z_1$  using the symbol  $y$ ; see Figure 4. Since  $\mathfrak{T}_2$  is the  $\omega$ -fork and  $\{y\}$  is a closed nowhere dense subset of  $Z_1$  such that  $\{Y_n \setminus \{y_n\} \mid n \in \omega\}$  is a clopen partition of  $Z_1 \setminus \{y\}$  satisfying  $y \in C_{Z_1}(Y_n \setminus \{y_n\})$ , it follows from Lemma 5.5 that there is an onto interior mapping  $\alpha_1 : Z_1 \rightarrow \mathfrak{T}_2$  such that  $\alpha_1^{-1}(r) = \{y\}$ .

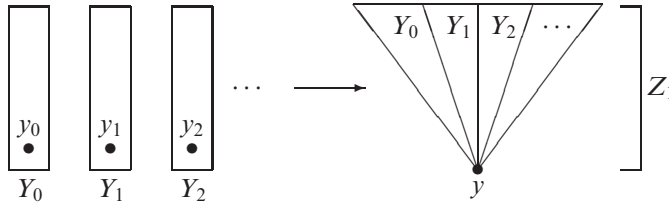

FIGURE 4. Realizing  $Z_1$  as a wedge sum of the  $Y_i$ .

**RECURSIVE STEP ( $n \geq 1$ ):** Suppose  $Z_n$  with the above properties is already built. Identify  $\mathfrak{T}_{n+1}$  with the subframe  $\mathfrak{T}_{n+2} \setminus \max(\mathfrak{T}_{n+2})$ . Enumerate  $\max(\mathfrak{T}_{n+1})$  as  $\{w_i \mid i \in \omega\}$ . Label points in  $\max(\mathfrak{T}_{n+2})$  as  $w_{i,j}$  where  $w_{i,j}$  is the  $j^{\text{th}}$  child of  $w_i$ . Let  $\alpha_n : Z_n \rightarrow \mathfrak{T}_{n+1}$  be an onto interior map such that  $(\alpha_n)^{-1}(r) = \{y\}$  where  $y$  is the point in the base case defining  $Z_1$ . Set  $X_i = (\alpha_n)^{-1}(\diamond_R \{w_i\})$ ; see Figure 5.

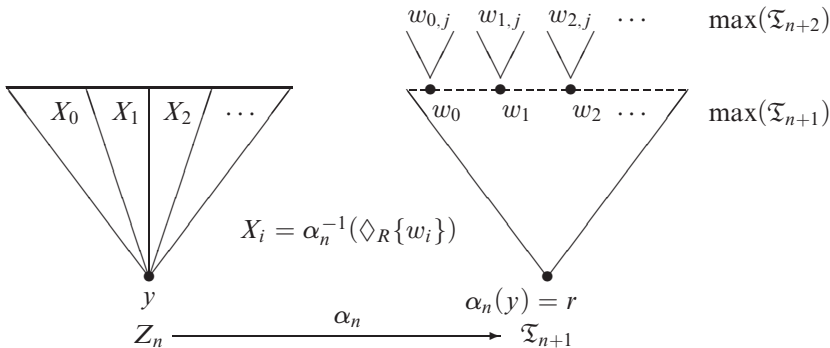

FIGURE 5. Mapping  $Z_n$  onto  $\mathfrak{T}_{n+1}$  viewed as a subframe of  $\mathfrak{T}_{n+2}$ .

Since  $X_i$  is countable, there is a continuous bijection  $f : \omega \rightarrow X_i$  which extends to a continuous onto map  $g : \beta\omega \rightarrow \beta X_i$ . Up to homeomorphism,  $\beta\omega$  is a subspace of

$\beta Y$  such that each point in  $\beta\omega$  is a remote point of  $Y$ . Consider the quotient space  $Q_i$  of  $\beta Y$  obtained by the equivalence relation whose only nontrivial equivalence classes are the fibers of  $g$ , namely  $g^{-1}(x)$  for each  $x \in \beta X_i$ . By [19, Theorem 2.4.13] the quotient mapping of  $\beta Y$  onto  $Q_i$  is closed. Intuitively,  $Q_i$  is obtained from  $\beta Y$  by replacing the copy of  $\beta\omega$  that ‘is remote from  $Y$ ’ by  $\beta X_i$ . We identify  $Y$ ,  $\beta X_i$ , and  $X_i$  with their respective images in  $Q_i$ , see Figure 6. For a nowhere dense subset  $N$  of  $Y$ , we have  $C_{\beta Y}(N) \cap \beta\omega = \emptyset$ , so  $C_{\beta Y}(N)$  is saturated, and hence  $C_{Q_i}(N) \cap \beta X_i = \emptyset$ .

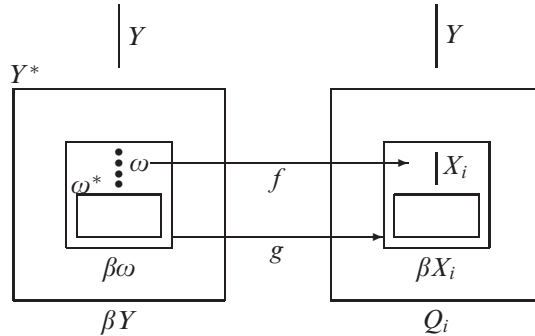

FIGURE 6. Identifying  $Y$ ,  $\beta X_i$ , and  $X_i$  in the quotient  $Q_i$  of  $\beta Y$ .

Viewing  $Y \cup X_i$  as a subspace of  $Q_i$ , the subsets  $Y$  and  $X_i$  are complements of each other,  $Y$  is dense, and  $X_i$  is closed and nowhere dense. Let  $A_i$  be the adjunction space of  $\omega$  copies of  $Y \cup X_i$  glued through the identity map on the copies of  $X_i$ . That is, up to homeomorphism,  $A_i$  is the quotient of the topological sum  $\bigoplus_{m \in \omega} (Y \cup X_i) \times \{m\}$  under the equivalence relation whose nontrivial equivalence classes are  $\{(x, m) \mid m \in \omega\}$  for each  $x \in X_i$ ; see Figure 7.

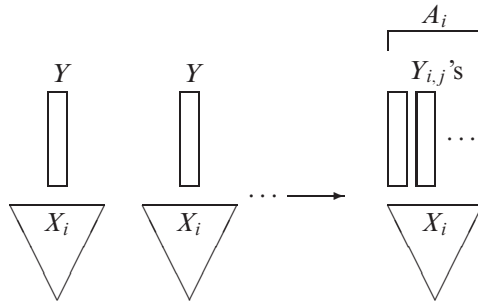

FIGURE 7. The adjunction space  $A_i$  obtained by gluing  $\omega$  copies of  $Y \cup X_i$  through  $X_i$ .

To facilitate defining  $\alpha_{n+1} : Z_{n+1} \rightarrow \mathfrak{T}_{n+2}$  we denote the  $\omega$  copies of  $Y$  in  $A_i$  by  $Y_{i,j}$  where  $j \in \omega$ . We also identify  $X_i$  with its homeomorphic copy in  $A_i$ . The quotient mapping from  $\bigoplus_{j \in \omega} (Y_{i,j} \cup X_i)$  onto  $A_i$  is closed. Thus, in  $A_i$  we have that  $\bigcup_{j \in \omega} Y_{i,j}$  and  $X_i$  are complements of each other,  $\bigcup_{j \in \omega} Y_{i,j}$  is dense, and  $X_i$  is closed and nowhere dense.

We define  $Z_{n+1}$  as the adjunction space of the  $A_i$  for  $i \in \omega$  through the following gluing. For each  $A_i$  consider the inclusion mapping  $I_i : X_i \rightarrow Z_n$ . Glue through

the equivalence relation whose nontrivial equivalence classes are  $\{(x_i, x_j) \mid x_i \in X_i, x_j \in X_j, I_i(x_i) = I_j(x_j)\}$ . Intuitively the gluing is through identifying points in  $X_i$  and  $X_j$  that are equal in  $Z_n$ ; see Figure 8. Identify the  $Y_{i,j}$ ,  $X_i$ , and  $Z_n$  with their images in  $Z_{n+1}$ . Observe that  $Y_{i,j}$  is open in  $Y_{i,j} \cup X_i$  and saturated in  $\bigoplus_{j \in \omega} (Y_{i,j} \cup X_i)$ , hence open in  $A_i$ . Similarly,  $Y_{i,j}$  is saturated in  $\bigoplus_{i \in \omega} A_i$ , and so open in  $Z_{n+1}$ . Thus, in  $Z_{n+1}$  we have that  $\bigcup_{i,j \in \omega} Y_{i,j}$  and  $Z_n$  are complements of each other,  $\bigcup_{i,j \in \omega} Y_{i,j}$  is dense and open, and  $Z_n$  is closed and nowhere dense.

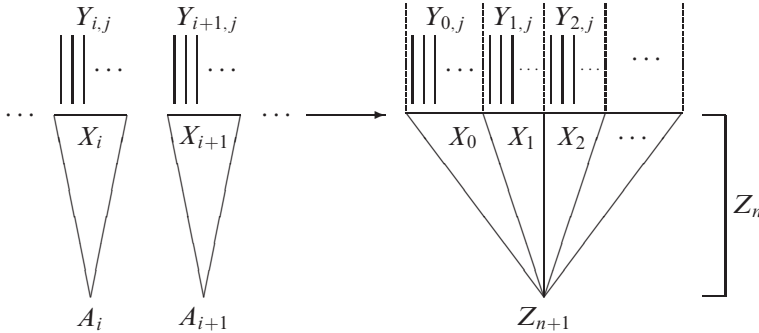

FIGURE 8. Attaching the  $A_i$  to obtain  $Z_{n+1}$ .

We now extend  $\alpha_n : Z_n \rightarrow \mathfrak{T}_{n+1}$  to  $\alpha_{n+1} : Z_{n+1} \rightarrow \mathfrak{T}_{n+2}$  by setting  $\alpha_{n+1}(z) = w_{i,j}$  for each  $z \in Y_{i,j}$ . Let  $w \in \mathfrak{T}_{n+2}$ . If  $w = w_{i,j} \in \max(\mathfrak{T}_{n+2})$ , then

$$\begin{aligned} \alpha_{n+1}^{-1}(\diamond_R \{w_{i,j}\}) &= \alpha_{n+1}^{-1}(\{w_{i,j}\} \cup \diamond_R \{w_i\}) = \alpha_{n+1}^{-1}(w_{i,j}) \cup \alpha_n^{-1}(\diamond_R \{w_i\}) \\ &= Y_{i,j} \cup X_i = \mathbf{C}_{Z_{n+1}}(Y_{i,j}) = \mathbf{C}_{Z_{n+1}} \alpha_{n+1}^{-1}(w_{i,j}). \end{aligned}$$

Otherwise  $w \in \mathfrak{T}_{n+1}$ , so since  $\alpha_n$  is interior and  $Z_n$  is closed in  $Z_{n+1}$ , we have

$$\alpha_{n+1}^{-1}(\diamond_R \{w\}) = \alpha_n^{-1}(\diamond_R \{w\}) = \mathbf{C}_{Z_n} \alpha_n^{-1}(w) = \mathbf{C}_{Z_{n+1}} \alpha_{n+1}^{-1}(w).$$

Thus,  $\alpha_{n+1}$  is interior and  $\alpha_{n+1}^{-1}(r) = \{y\}$ .

LEMMA 5.6. Let  $X = \bigoplus_{i \in \omega} Y_i$ . For  $n \in \omega$ , if  $0 \leq \text{mdim}(Y_i) \leq n$  for each  $i$ , then  $\text{mdim}(X) \leq n$ .

PROOF. Induction on  $n$ .

BASE CASE ( $n = 0$ ): Suppose  $\text{mdim}(Y_i) = 0$  for each  $i$ . Let  $N$  be nowhere dense in  $X$ . Then  $N_i = N \cap Y_i$  is nowhere dense in  $Y_i$ . Therefore,  $\text{mdim}(N_i) = -1$ , and so  $N_i = \emptyset$ . Thus,  $N = \emptyset$ . From this it follows that  $\text{mdim}(N) = -1$ , and hence  $\text{mdim}(X) = 0$ .

INDUCTIVE STEP ( $n \geq 0$ ): Suppose for any family of spaces  $\{Y'_i \mid i \in \omega\}$ , if  $0 \leq \text{mdim}(Y'_i) \leq n$  for each  $i$ , then  $\text{mdim}(\bigoplus_{i \in \omega} Y'_i) \leq n$ . Assume  $0 \leq \text{mdim}(Y_i) \leq n + 1$  for each  $i \in \omega$ . Let  $N$  be nowhere dense in  $X$ . Then  $Y'_i = N \cap Y_i$  is nowhere dense in  $Y_i$ . Therefore,  $\text{mdim}(Y'_i) \leq n$ . By the inductive hypothesis,  $\text{mdim}(N) \leq n$ . Thus,  $\text{mdim}(X) \leq n + 1$ . □

LEMMA 5.7. For  $n \geq 1$ ,  $\text{mdim}(Z_n) = n$ .

PROOF. Since  $\mathfrak{T}_{n+1}$  is an interior image of  $Z_n$ , the  $(n + 1)$ -element chain is an interior image of  $Z_n$ . By Theorem 3.6,  $\text{mdim}(Z_n) \geq n$ . We show that  $\text{mdim}(Z_n) \leq n$  by induction on  $n \geq 1$ .



BASE CASE ( $n = 1$ ): Let  $N$  be nowhere dense in  $Z_1$ . Set  $N_i = N \cap Y_i$  for each  $i \in \omega$ . Then  $N_i$  is nowhere dense in  $Z_1$ . Noting that  $Y_i$  is a closed subspace of  $Z_1$  homeomorphic to  $Y$  (which is a dense-in-itself  $T_1$ -space), it follows that  $N_i$  is nowhere dense in  $Y_i$ . Because  $Y$  is nodec,  $Y_i$  is nodec, and so  $N_i$  is closed in  $Y_i$ . Let  $N'$  be the union of the  $N_i$  in the topological sum of the  $Y_i$  which is the preimage of the adjunction space  $Z_1$ . Then  $N'$  is closed in the sum. Since  $N'$  is the preimage of  $N$ , we see that  $N$  is closed in  $Z_1$ . Therefore,  $Z_1$  is nodec. Because  $Z_1$  is a  $T_1$ -space, it follows from Theorem 4.9 that  $\text{mdim}(Z_1) \leq 1$ .

INDUCTIVE STEP ( $n \geq 1$ ): Assume  $\text{mdim}(Z_n) = n$ . Since  $Z_{n+1}$  was constructed in three stages, our proof is also in three stages. First we show that  $\text{mdim}(Y \cup X_i) \leq n + 1$ , next that  $\text{mdim}(A_i) \leq n + 1$ , and finally that  $\text{mdim}(Z_{n+1}) \leq n + 1$ .

STAGE 1: Since  $\text{mdim}(Z_n) = n$  and each  $X_i \subseteq Z_n$ , by Lemma 3.3,  $\text{mdim}(X_i) \leq n$ . Also, the  $(n + 1)$ -element chain is an interior image of  $X_i$ , giving that  $\text{mdim}(X_i) \geq n$ . Thus,  $\text{mdim}(X_i) = n$ .

Let  $N$  be nowhere dense in  $Y \cup X_i$ , and set  $M = N \cap Y$ . Then  $M$  is nowhere dense in  $Y \cup X_i$ . Let  $U$  be an open subset of  $Y$  contained in  $C_Y M$ . Since  $Y$  is open in  $Y \cup X_i$ , we have that  $U$  is open in  $Y \cup X_i$  and is contained in  $C_Y M \subseteq CM$ . Because  $M$  is nowhere dense in  $Y \cup X_i$ , we obtain  $U = \emptyset$ , and so  $M$  is nowhere dense in  $Y$ . Since  $Y$  is nodec,  $M$  is closed and discrete in  $Y$ . By the construction of  $Y \cup X_i$ , each  $x \in X_i$  is the image of a set of points each remote from  $Y$ , and hence  $CM \cap X_i = \emptyset$ . Thus,  $CM \subseteq Y$ , from which it follows that  $C_Y M = CM$ . Therefore, since  $M$  is closed in  $Y$ , it is closed in  $Y \cup X_i$ . Consequently,  $M$  is closed in  $N$ . In fact,  $M$  is clopen in  $N$  since  $Y$  is open and  $M = N \cap Y$ . Therefore,  $N$  is the disjoint union of  $M$  and  $N \cap X_i$ . As  $M$  is discrete,  $\text{mdim}(M) \leq 0$ . Also, since  $N \cap X_i$  is a subspace of  $X_i$ , we have  $\text{mdim}(N \cap X_i) \leq \text{mdim}(X_i) = n$ . By Lemma 5.6,  $\text{mdim}(N) \leq n$ . Thus,  $\text{mdim}(Y \cup X_i) \leq n + 1$ .

STAGE 2: Let  $N$  be nowhere dense in  $A_i$ . Set  $N_j = N \cap Y_{i,j}$ . Recalling that  $Y_{i,j} \cup X_i$  is homeomorphic to  $Y \cup X_i$ , by replacing  $M$  by  $N_j$  and  $Y \cup X_i$  by  $Y_{i,j} \cup X_i$  in the proof of Stage 1, we see that  $N_j$  is closed in  $Y_{i,j} \cup X_i$  and  $N_j \cap X_i = \emptyset$  for all  $j \in \omega$ . Therefore,  $\bigcup_{j \in \omega} N_j$  is closed in the topological sum  $\bigoplus_{j \in \omega} (Y_{i,j} \cup X_i)$ . Since  $\bigcup_{j \in \omega} N_j$  is also saturated in  $\bigoplus_{j \in \omega} (Y_{i,j} \cup X_i)$ , it is closed in  $A_i$ , and hence closed in  $N$ . Also,  $\bigcup_{j \in \omega} N_j = N \cap \bigcup_{j \in \omega} Y_{i,j}$  is open in  $N$  since  $\bigcup_{j \in \omega} Y_{i,j}$  is open in  $A_i$ . Therefore,  $N$  is the disjoint union of  $N \cap X_i$  and  $\bigcup_{j \in \omega} N_j$ . By Lemma 5.6,  $\text{mdim}(\bigcup_{j \in \omega} N_j) \leq 1 \leq n$  since  $\text{mdim}(N_j) \leq \text{mdim}(Y_{i,j}) \leq 1$ . Also  $\text{mdim}(N \cap X_i) \leq \text{mdim}(X_i) = n$ , so utilizing Lemma 5.6 again yields  $\text{mdim}(N) \leq n$ . Thus,  $\text{mdim}(A_i) \leq n + 1$ .

STAGE 3: Let  $N$  be nowhere dense in  $Z_{n+1}$ . Set  $N_i = (N \cap A_i) \setminus X_i$ . By recognizing that  $N_i$  is realized within the discussion of Stage 2 as  $\bigcup_{j \in \omega} N_j$ , we see that each  $N_i$  is closed in  $A_i$ , and hence  $\bigcup_{i \in \omega} N_i$  is closed in  $\bigoplus_{i \in \omega} A_i$ . Moreover,  $\bigcup_{i \in \omega} N_i$  is saturated, and so  $\bigcup_{i \in \omega} N_i$  is closed in  $Z_{n+1}$ . Therefore,  $\bigcup_{i \in \omega} N_i$  is also closed in  $N$ . But  $\bigcup_{i \in \omega} N_i = N \cap (Z_{n+1} \setminus Z_n)$ , so  $\bigcup_{i \in \omega} N_i$  is open in  $N$ . Thus,  $N$  is the disjoint union of  $N \cap Z_n$  and  $\bigcup_{i \in \omega} N_i$ . Since  $\text{mdim}(N_i) \leq \text{mdim}(A_i \setminus X_i) = \text{mdim}(\bigoplus_{j \in \omega} Y_{i,j}) \leq 1$ , Lemma 5.6 yields that  $\text{mdim}(\bigcup_{i \in \omega} N_i) \leq 1 \leq n$ . Also  $\text{mdim}(N \cap Z_n) \leq \text{mdim}(Z_n) = n$ , so by Lemma 5.6,  $\text{mdim}(N) \leq n$ . Consequently,  $\text{mdim}(Z_{n+1}) \leq n + 1$ . +

**5.3. Completeness.** Since  $\mathbf{S4.Z}_n$  has the finite model property,  $\mathbf{S4.Z}_n$  is the logic of finite uniquely rooted  $\mathbf{S4}$ -frames  $\mathfrak{F}$  of depth  $\leq n + 1$ . Since each such  $\mathfrak{F}$  can be unraveled into a uniquely rooted finite quasi-tree  $\mathfrak{T}$  whose depth is  $\leq n + 1$ , we see that  $\mathbf{S4.Z}_n$  is the logic of uniquely rooted finite quasi-trees  $\mathfrak{T}$  of depth  $\leq n + 1$ .

Let  $\mathcal{Q}_n$  be the quasi-tree whose skeleton is  $\mathfrak{T}_n$  and in which the root cluster is the only trivial cluster and all other clusters are countably infinite. Clearly identifying the clusters yields an onto  $\mathfrak{p}$ -morphism  $p_n : \mathcal{Q}_n \rightarrow \mathfrak{T}_n$ . Because every uniquely rooted finite quasi-tree of depth  $\leq n + 1$  is an interior image of  $\mathcal{Q}_{n+1}$ , we see that  $\mathbf{S4.Z}_n$  is the logic of  $\mathcal{Q}_{n+1}$ . Since we will utilize this fact, we state it as a lemma.

LEMMA 5.8.  $\mathbf{S4.Z}_n$  is the logic of  $\mathcal{Q}_{n+1}$ .

Since  $\text{mdim}(Z_n) = n$  and  $Z_n$  is  $T_1$ , we see that  $Z_n \models \mathbf{S4.Z}_n$ . Therefore, to show that  $\mathbf{S4.Z}_n$  is the logic of  $Z_n$ , in view of Lemma 5.8, it is sufficient to prove that  $\mathcal{Q}_{n+1}$  is an interior image of  $Z_n$ . The idea of the proof is to ‘fatten’ the mapping  $\alpha_n : Z_n \rightarrow \mathfrak{T}_{n+1}$  to a mapping  $Z_n \rightarrow \mathcal{Q}_{n+1}$ . Let  $\mathfrak{C}_\kappa$  be the  $\kappa$ -cluster as depicted in Figure 9.

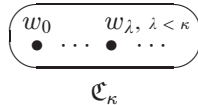

FIGURE 9. The  $\kappa$ -cluster.

LEMMA 5.9. A space  $X$  is  $\kappa$ -resolvable iff  $\mathfrak{C}_\kappa$  is an interior image of  $X$ .

PROOF. First suppose that  $X$  is  $\kappa$ -resolvable. Then there is a dense partition  $\{D_\lambda : \lambda < \kappa\}$  of  $X$ . Define  $f : X \rightarrow \mathfrak{C}_\kappa$  by  $f(x) = w_\lambda$  if  $x \in D_\lambda$ . Clearly  $f$  is a well-defined onto map. Moreover, for each  $\lambda < \kappa$ , we have

$$\mathbf{C}f^{-1}(w_\lambda) = \mathbf{C}(D_\lambda) = X = f^{-1}(\{w_\lambda : \lambda < \kappa\}) = f^{-1}(\diamond_R\{w_\lambda\}).$$

Thus,  $f$  is an interior map.

Conversely, let  $f : X \rightarrow \mathfrak{C}_\kappa$  be an onto interior map. Then  $\{f^{-1}(w_\lambda) : \lambda < \kappa\}$  is a partition of  $X$  such that

$$\mathbf{C}f^{-1}(w_\lambda) = f^{-1}(\diamond_R\{w_\lambda\}) = f^{-1}(\{w_\lambda : \lambda < \kappa\}) = X.$$

Thus,  $\{f^{-1}(w_\lambda) : \lambda < \kappa\}$  is a dense partition of  $X$ , and hence  $X$  is  $\kappa$ -resolvable.  $\dashv$

THEOREM 5.10. For each  $n \geq 1$ ,  $\mathbf{S4.Z}_n$  is the logic of  $Z_n$ .

PROOF. As we already pointed out, in view of Lemma 5.8, it is sufficient to show that  $\mathcal{Q}_{n+1}$  is an interior image of  $Z_n$ . The proof is by induction on  $n$ .

Let  $n = 1$ . Let  $\mathfrak{C}_i$  be the maximal cluster in  $\mathcal{Q}_2$  whose  $p_2$ -image is  $w_i \in \max(\mathfrak{T}_2)$  (here we are using the enumeration of  $\max(\mathfrak{T}_2)$  as it appears in the recursive step of defining the  $Z_n$ ). So  $\mathfrak{C}_i = p_2^{-1}(w_i)$ . Since each  $Y_i \setminus \{y_i\}$  is an open subspace of  $Y_i$ ,  $Y_i$  is homeomorphic to  $Y$ , and  $Y$  is  $\omega$ -resolvable, we see that each  $Y_i \setminus \{y_i\}$  is  $\omega$ -resolvable. As  $Y_i \setminus \{y_i\}$  is homeomorphic to the subspace  $Y_i \setminus \{y\}$  of  $Z_1$ , by Lemma 5.9, there is an onto interior map  $f_i : Y_i \setminus \{y\} \rightarrow \mathfrak{C}_i$ . Define  $f : Z_1 \rightarrow \mathcal{Q}_2$  by

$$f(z) = \begin{cases} f_i(z) & \text{if } z \in Y_i \setminus \{y\}, \\ r & \text{if } z = y. \end{cases}$$

Since  $\{Y_i \setminus \{y\} \mid i \in \omega\} \cup \{y\}$  is a partition of  $Z_1$  and each  $f_i$  is onto,  $f$  is a well-defined onto map. Let  $w \in Q_2$ . Suppose  $w \in \mathfrak{C}_i$  for some  $i \in \omega$ . Then

$$\begin{aligned} f^{-1}(\diamond_R\{w\}) &= f^{-1}(\mathfrak{C}_i \cup \{r\}) = f_i^{-1}(\mathfrak{C}_i) \cup \{y\} \\ &= (Y_i \setminus \{y\}) \cup \{y\} = \mathbf{C}_{Z_1}(Y_i \setminus \{y\}) = \mathbf{C}_{Z_1}f^{-1}(w). \end{aligned}$$

Otherwise  $w$  is the root, and so

$$f^{-1}(\diamond_R\{w\}) = f^{-1}(w) = \{y\} = \mathbf{C}_{Z_1}\{y\} = \mathbf{C}_{Z_1}f^{-1}(w).$$

Thus,  $f : Z_1 \rightarrow Q_2$  is an onto interior map.

Let  $n \geq 1$ . Suppose  $g : Z_n \rightarrow Q_{n+1}$  is an onto interior map. Identify  $Q_{n+1}$  with the subframe  $Q_{n+2} \setminus \max_R(Q_{n+2})$ . Let  $w_{i,j} \in \max(\mathfrak{T}_{n+2})$  be the  $j^{\text{th}}$  child of  $w_i \in \max(\mathfrak{T}_{n+1})$  (as in the recursive step of building the  $Z_n$ ). Let  $\mathfrak{C}_{i,j}$  be the maximal cluster in  $Q_{n+2}$  whose  $p_{n+2}$ -image is  $w_{i,j}$ . So  $\mathfrak{C}_{i,j} = p_{n+2}^{-1}(w_{i,j})$ . Also, let  $\mathfrak{C}_i$  be the maximal cluster in  $Q_{n+1}$  whose  $p_{n+2}$ -image is  $w_i \in \max(\mathfrak{T}_{n+1})$ . So  $\mathfrak{C}_i = p_{n+2}^{-1}(w_i)$ . Since each subspace  $Y_{i,j}$  of  $Z_{n+1}$  is homeomorphic to  $Y$ , we see that  $Y_{i,j}$  is  $\omega$ -resolvable. By Lemma 5.9, there is an onto interior map  $f_{i,j} : Y_{i,j} \rightarrow \mathfrak{C}_{i,j}$ . Define  $f : Z_{n+1} \rightarrow Q_{n+2}$  by

$$f(z) = \begin{cases} f_{i,j}(z) & \text{if } z \in Y_{i,j}, \\ g(z) & \text{if } z \in Z_n. \end{cases}$$

Since  $\{Y_{i,j} \mid i, j \in \omega\} \cup \{Z_n\}$  is a partition of  $Z_{n+1}$  and the  $f_{i,j}$  and  $g$  are onto,  $f$  is a well-defined onto map. Let  $w \in Q_{n+2}$ . Suppose  $w \in \mathfrak{C}_{i,j}$  for some  $i, j \in \omega$ . Because  $Z_n$  is closed in  $Z_{n+1}$ , both  $g$  and  $f_{i,j}$  are interior maps, and  $g^{-1}(\diamond_R\mathfrak{C}_i) = X_i$ , we have

$$\begin{aligned} f^{-1}(\diamond_R\{w\}) &= f^{-1}(\mathfrak{C}_{i,j} \cup \diamond_R\mathfrak{C}_i) = f_{i,j}^{-1}(\mathfrak{C}_{i,j}) \cup g^{-1}(\diamond_R\mathfrak{C}_i) = Y_{i,j} \cup X_i \\ &= \mathbf{C}_{Z_{n+1}}Y_{i,j} = \mathbf{C}_{Z_{n+1}}(\mathbf{C}_{Y_{i,j}}f_{i,j}^{-1}(w)) = \mathbf{C}_{Z_{n+1}}f^{-1}(w). \end{aligned}$$

Otherwise  $w \in Q_{n+1}$ , and so

$$f^{-1}(\diamond_R\{w\}) = g^{-1}(\diamond_R\{w\}) = \mathbf{C}_{Z_n}g^{-1}(w) = \mathbf{C}_{Z_{n+1}}f^{-1}(w).$$

Thus,  $f : Z_{n+1} \rightarrow Q_{n+2}$  is an onto interior map. ◄

As an immediate consequence, we obtain:

**COROLLARY 5.11.** *For each  $n \geq 1$ ,  $\mathbf{S4.Z}_n$  is the logic of a countable dense-in-itself  $\omega$ -resolvable Tychonoff space of modal Krull dimension  $n$ .*

Moreover, since  $\mathbf{S4.Z} = \mathbf{S4.Z}_1$ , we obtain the following topological completeness for the Zeman logic:

**COROLLARY 5.12.**  *$\mathbf{S4.Z}$  is the logic of a countable dense-in-itself  $\omega$ -resolvable Tychonoff nodec space.*

That  $\mathbf{S4.Z}$  is the logic of nodec spaces was shown in [3, Theorem 4.6], but the proof required the use of Alexandroff nodec spaces. The above corollary strengthens this result considerably by providing a topologically “nice” nodec space whose logic is  $\mathbf{S4.Z}$ .

**§6. Krull dimension of Heyting algebras.** In this section we turn to Heyting algebras, which are closely related to **S4**-algebras [38, 42]. We utilize this connection and our results about the Krull dimension of **S4**-algebras to define the Krull dimension of a Heyting algebra both externally and internally, and show that these definitions are equivalent. We also show how to give an equivalent definition of the modal Krull dimension of a topological space in terms of the Heyting algebra of open sets.

DEFINITION 6.1. A *Heyting algebra* is a bounded implicative lattice; that is, a bounded distributive lattice such that  $\wedge$  has a residual  $\rightarrow$  satisfying

$$x \leq a \rightarrow b \text{ iff } a \wedge x \leq b.$$

As usual, we let  $\neg a$  denote  $a \rightarrow 0$ .

If  $\mathfrak{A}$  is an **S4**-algebra, then  $\mathfrak{H}(\mathfrak{A}) := \{\Box a \mid a \in \mathfrak{A}\}$  is a Heyting algebra in which  $a \rightarrow b = \Box(\neg a \vee b)$ . Conversely, if  $\mathfrak{H}$  is a Heyting algebra, then the free Boolean extension  $\mathfrak{B}(\mathfrak{H})$  of  $\mathfrak{H}$  can be equipped with  $\Box$  so that  $\mathfrak{A}(\mathfrak{H}) := (\mathfrak{B}(\mathfrak{H}), \Box)$  is an **S4**-algebra,  $\mathfrak{H}$  is isomorphic to  $\mathfrak{H}(\mathfrak{A}(\mathfrak{H}))$ , and  $\mathfrak{A}(\mathfrak{H}(\mathfrak{A}))$  is isomorphic to a subalgebra of  $\mathfrak{A}$  (see, e.g., [42, Sections IV.1 and IV.3] or [21, Sections II.2 and II.5]).

As with **S4**-algebras, there are two typical examples of Heyting algebras. Firstly, the collection  $\mathfrak{H}_X$  of all open sets of a topological space  $X$  is a Heyting algebra, where  $U \rightarrow V = \mathbf{I}((X \setminus U) \cup V)$ . By the Stone representation theorem [44], every Heyting algebra is represented as a subalgebra of  $\mathfrak{H}_X$  for some topological space  $X$  (see [38, 42]). Secondly, the  $R$ -upsets of an **S4**-frame form a Heyting algebra, but since  $R$ -upsets do not distinguish between points that are  $R$ -related to each other, we may restrict ourselves to those **S4**-frames that are in addition antisymmetric. More precisely, the Heyting algebras of  $R$ -upsets of  $\mathfrak{F}$  and the skeleton of  $\mathfrak{F}$  are isomorphic, and every Heyting algebra is represented as a subalgebra of the Heyting algebra of  $R$ -upsets of some partially ordered **S4**-frame (see, e.g., [21, 25]).

The dual  $\mathfrak{H}_*$  of a Heyting algebra  $\mathfrak{H}$  is the spectrum of prime filters of  $\mathfrak{H}$ . If  $\mathfrak{A}$  is an **S4**-algebra and  $\mathfrak{A}_*$  is the dual of  $\mathfrak{A}$ , then the dual  $\mathfrak{H}(\mathfrak{A})_*$  of  $\mathfrak{H}(\mathfrak{A})$  is obtained by taking the skeleton of  $\mathfrak{A}_*$ . Conversely, if  $\mathfrak{H}$  is a Heyting algebra, then the dual  $\mathfrak{A}(\mathfrak{H})_*$  of  $\mathfrak{A}(\mathfrak{H})$  is isomorphic to the dual  $\mathfrak{H}_*$  of  $\mathfrak{H}$  (see, e.g., [21, Section III.4]).

Let  $\mathfrak{H}$  be a Heyting algebra and  $a \in \mathfrak{H}$ . The *relativization* of  $\mathfrak{H}$  with respect to  $a$  is the Heyting algebra  $\mathfrak{H}_a$  whose underlying set is the interval  $[a, 1]$  and  $\wedge, \vee,$  and  $\rightarrow$  in  $\mathfrak{H}_a$  coincide with those in  $\mathfrak{H}$ . If  $\mathfrak{H} = \mathfrak{H}_X$  is the Heyting algebra of all opens of a topological space  $X$  and  $U$  is an open subset of  $X$ , then the relativization of  $\mathfrak{H}$  with respect to  $U$  is isomorphic to the Heyting algebra of all opens of the subspace  $X \setminus U$ .

We are ready to define Krull dimension of Heyting algebras. As with **S4**-algebras, we first define Krull dimension of Heyting algebras externally and then provide an equivalent internal definition of it. We also show that Krull dimensions of an **S4**-algebra  $\mathfrak{A}$  and the associated Heyting algebra  $\mathfrak{H}(\mathfrak{A})$  coincide.

DEFINITION 6.2. Let  $\mathfrak{H}$  be a Heyting algebra. Define the *Krull dimension*  $\text{kdim}(\mathfrak{H})$  of  $\mathfrak{H}$  as the supremum of the lengths of finite  $R$ -chains in  $\mathfrak{H}_*$ . If the supremum is not finite, then we write  $\text{kdim}(\mathfrak{H}) = \infty$ .

LEMMA 6.3.

1. If  $\mathfrak{A}$  is an **S4**-algebra, then  $\text{kdim}(\mathfrak{A}) = \text{kdim}(\mathfrak{H}(\mathfrak{A}))$ .
2. If  $\mathfrak{H}$  is a Heyting algebra, then  $\text{kdim}(\mathfrak{H}) = \text{kdim}(\mathfrak{A}(\mathfrak{H}))$ .

PROOF. (1) Since  $\mathfrak{H}(\mathfrak{A})_*$  is the skeleton of  $\mathfrak{A}_*$ , we see that the corresponding  $R$ -chains in  $\mathfrak{A}_*$  and  $\mathfrak{H}(\mathfrak{A})_*$  have the same length. Thus,  $\text{kdim}(\mathfrak{A}) = \text{kdim}(\mathfrak{H}(\mathfrak{A}))$ .

(2) This is obvious since  $\mathfrak{H}_*$  is isomorphic to  $(\mathfrak{A}(\mathfrak{H}))_*$ . ◊

As with **S4**-algebras, the concept of Krull dimension of a Heyting algebra  $\mathfrak{H}$  is closely related to that of the depth of  $\mathfrak{H}$ . It is well known that whether the depth of  $\mathfrak{H}$  is  $\leq n$  is described by the following formulas in the language of intuitionistic logic.

DEFINITION 6.4. For  $n \geq 1$ , consider the formulas:

$$\begin{aligned} \text{ibd}_1 &= p_1 \vee \neg p_1, \\ \text{ibd}_{n+1} &= p_{n+1} \vee (p_{n+1} \rightarrow \text{ibd}_n). \end{aligned}$$

The intuitionistic language is interpreted in a Heyting algebra  $\mathfrak{H}$  by assigning to propositional letters elements of  $\mathfrak{H}$  and by interpreting conjunction, disjunction, implication, and negation as the corresponding operations of  $\mathfrak{H}$ . The next lemma is well known (see, e.g., [10, Proposition 2.38]).

LEMMA 6.5. *Let  $\mathfrak{H}$  be a nontrivial Heyting algebra and  $n \geq 1$ . Then  $\mathfrak{H} \models \text{ibd}_n$  iff  $\text{depth}(\mathfrak{H}_*) \leq n$ .*

To characterize the Krull dimension of a Heyting algebra internally, we require some preparation. We call an element  $a$  of a Heyting algebra  $\mathfrak{H}$  *dense* if  $\neg a = 0$ .

LEMMA 6.6. *Let  $\mathfrak{H}$  be a Heyting algebra,  $a \in \mathfrak{H}$ , and  $b \in \mathfrak{H}_a$ . If  $b$  is dense in  $\mathfrak{H}_a$ , then  $b$  is dense in  $\mathfrak{H}$ .*

PROOF. Since  $b$  is dense in  $\mathfrak{H}_a$  and  $a$  is the bottom of  $\mathfrak{H}_a$ , we have  $b \rightarrow a = a$ . Therefore,  $\neg b = b \rightarrow 0 \leq b \rightarrow a = a$ . On the other hand,  $a \leq b$  implies  $\neg b \leq \neg a$ . Thus,  $\neg b \leq a \wedge \neg a = 0$ , and hence  $b$  is dense in  $\mathfrak{H}$ . ◊

LEMMA 6.7. *Let  $\mathfrak{A}$  be an **S4**-algebra and let  $a, b \in \mathfrak{H}(\mathfrak{A})$  with  $b \leq a$ . Then  $a$  is dense in  $\mathfrak{H}(\mathfrak{A})_b$  iff  $\neg a$  is nowhere dense in  $\mathfrak{A}_{\neg b}$ .*

PROOF. Since  $a, b$  are open,  $\neg a, \neg b$  are closed. Therefore, since  $\neg a \leq \neg b$ , we have  $\neg a = \diamond \neg a = \neg b \wedge \diamond \neg a = \diamond_{\neg b} \neg a$ . Thus,

$$\begin{aligned} a \text{ is dense in } \mathfrak{H}(\mathfrak{A})_b &\text{ iff } \neg a = 0 \text{ in } \mathfrak{H}(\mathfrak{A})_b \\ &\text{ iff } a \rightarrow b = b \text{ in } \mathfrak{H}(\mathfrak{A}) \\ &\text{ iff } \Box(\neg a \vee b) = b \text{ in } \mathfrak{A} \\ &\text{ iff } \Box(\neg b \rightarrow \neg a) = b \text{ in } \mathfrak{A} \\ &\text{ iff } \neg b \wedge \Box(\neg b \rightarrow \neg a) = 0 \text{ in } \mathfrak{A} \\ &\text{ iff } \Box_{\neg b} \neg a = 0 \text{ in } \mathfrak{A}_{\neg b} \\ &\text{ iff } \Box_{\neg b} \diamond_{\neg b} \neg a = 0 \text{ in } \mathfrak{A}_{\neg b} \\ &\text{ iff } \neg a \text{ is nowhere dense in } \mathfrak{A}_{\neg b}. \end{aligned} \quad \text{◊}$$

REMARK 6.8. When  $b = 0$ , we obtain that  $a$  is dense in  $\mathfrak{H}(\mathfrak{A})$  iff  $\neg a$  is nowhere dense in  $\mathfrak{A}$ .

We are ready to give an internal recursive definition of the Krull dimension of a Heyting algebra.

DEFINITION 6.9. The *Krull dimension*  $\text{kdim}(\mathfrak{H})$  of a Heyting algebra  $\mathfrak{H}$  can be defined as follows:

- $\text{kdim}(\mathfrak{H}) = -1$  if  $\mathfrak{H}$  is the trivial algebra,
- $\text{kdim}(\mathfrak{H}) \leq n$  if  $\text{kdim}(\mathfrak{H}_b) \leq n - 1$  for every dense  $b \in \mathfrak{H}$ ,
- $\text{kdim}(\mathfrak{H}) = n$  if  $\text{kdim}(\mathfrak{H}) \leq n$  and  $\text{kdim}(\mathfrak{H}) \not\leq n - 1$ ,
- $\text{kdim}(\mathfrak{H}) = \infty$  if  $\text{kdim}(\mathfrak{H}) \not\leq n$  for any  $n = -1, 0, 1, 2, \dots$

The next two results concern the internal definition of the Krull dimension.

LEMMA 6.10. *Let  $\mathfrak{H}$  be a Heyting algebra and let  $a \in \mathfrak{H}$ . Then  $\text{kdim}(\mathfrak{H}_a) \leq \text{kdim}(\mathfrak{H})$ .*

PROOF. If  $\text{kdim}(\mathfrak{H}) = \infty$ , then there is nothing to prove. Suppose  $\text{kdim}(\mathfrak{H}) = n$ . Let  $b \in \mathfrak{H}_a$  be dense in  $\mathfrak{H}_a$ . By Lemma 6.6,  $b$  is dense in  $\mathfrak{H}$ . Since  $\text{kdim}(\mathfrak{H}) = n$ , we see that  $\text{kdim}(\mathfrak{H}_b) \leq n - 1$ . Because  $(\mathfrak{H}_a)_b = \mathfrak{H}_b$ , we conclude that  $\text{kdim}(\mathfrak{H}_a) \leq n$ . Thus,  $\text{kdim}(\mathfrak{H}_a) \leq \text{kdim}(\mathfrak{H})$ . ⊢

THEOREM 6.11.

1. *If  $\mathfrak{A}$  is an **S4**-algebra, then  $\text{kdim}(\mathfrak{A}) = \text{kdim}(\mathfrak{H}(\mathfrak{A}))$ .*
2. *If  $\mathfrak{H}$  is a Heyting algebra, then  $\text{kdim}(\mathfrak{H}) = \text{kdim}(\mathfrak{A}(\mathfrak{H}))$ .*

PROOF. (1) By Theorem 2.14,  $\text{kdim}(\mathfrak{A}) \geq n$  iff there is a sequence  $c_0, \dots, c_n$  of nonzero closed elements of  $\mathfrak{A}$  such that  $c_0 = 1$  and  $c_{i+1}$  is nowhere dense in  $\mathfrak{A}_{c_i}$  for each  $i \in \{0, \dots, n - 1\}$ . By [4, Theorem 6.9],  $\text{kdim}(\mathfrak{H}(\mathfrak{A})) \geq n$  iff there is a sequence  $1 = b_0 > b_1 > \dots > b_n > 0$  in  $\mathfrak{H}(\mathfrak{A})$  such that  $b_{i-1}$  is dense in  $\mathfrak{H}(\mathfrak{A})_{b_i}$  for each  $i \in \{1, \dots, n\}$ . The two conditions are equivalent by Lemma 6.7. The result follows.

(2) Since  $\mathfrak{H}$  is isomorphic to  $\mathfrak{H}(\mathfrak{A}(\mathfrak{H}))$ , we have  $\text{kdim}(\mathfrak{H}) = \text{kdim}(\mathfrak{H}(\mathfrak{A}(\mathfrak{H})))$ . By (1),  $\text{kdim}(\mathfrak{H}(\mathfrak{A}(\mathfrak{H}))) = \text{kdim}(\mathfrak{A}(\mathfrak{H}))$ . Thus,  $\text{kdim}(\mathfrak{H}) = \text{kdim}(\mathfrak{A}(\mathfrak{H}))$ . ⊢

As a consequence we obtain:

COROLLARY 6.12. *The external and internal definitions of the Krull dimension of a Heyting algebra coincide, so Definitions 6.2 and 6.9 are equivalent.*

PROOF. Apply Corollary 2.16, Lemma 6.3, and Theorem 6.11. ⊢

COROLLARY 6.13. *For a topological space  $X$ , we have  $\text{mdim}(X) = \text{kdim}(\mathfrak{H}_X)$ .*

PROOF. Since  $\mathfrak{H}_X$  is the Heyting algebra of opens of  $\mathfrak{A}_X$ , by Lemma 6.3 (or Theorem 6.11),  $\text{mdim}(X) = \text{kdim}(\mathfrak{A}_X) = \text{kdim}(\mathfrak{H}_X)$ . ⊢

Let  $\mathfrak{L}_n$  be the  $(n + 1)$ -element linear Heyting algebra. Then  $(\mathfrak{L}_n)_*$  is isomorphic to the  $n$ -element chain  $\mathfrak{F}_n$  shown in Figure 1. Let  $\chi(\mathfrak{L}_n)$  be the Jankov–Fine formula of  $\mathfrak{L}_n$ . Another immediate consequence of our results is the following:

COROLLARY 6.14. *Let  $\mathfrak{H}$  be a nontrivial Heyting algebra and  $n \geq 1$ . The following are equivalent:*

1.  $\text{kdim}(\mathfrak{H}) \leq n - 1$ .
2. *There does not exist a sequence  $1 = b_0 > b_1 > \dots > b_n > 0$  in  $\mathfrak{H}$  such that  $b_{i-1}$  is dense in  $\mathfrak{H}_{b_i}$  for each  $i \in \{1, \dots, n\}$ .*
3.  $\mathfrak{H} \models \text{ibd}_n$ .
4.  $\text{depth}(\mathfrak{H}_*) \leq n$ .
5.  $\mathfrak{H} \models \neg\chi(\mathfrak{L}_{n+1})$ .
6.  $\mathfrak{L}_{n+1}$  is not isomorphic to a subalgebra of a homomorphic image of  $\mathfrak{H}$ .
7.  $\mathfrak{L}_{n+1}$  is not isomorphic to a subalgebra of  $\mathfrak{H}$ .

§7. **Comparison to other dimension functions.** We conclude the paper with a comparison of modal Krull dimension to other well-known topological dimension

functions. We recall that if  $X$  is a regular space, then the Menger-Urysohn dimension of  $X$  is denoted by  $\text{ind}(X)$ , if  $X$  is a Tychonoff space, then the Čech-Lebesgue dimension of  $X$  is denoted by  $\text{dim}(X)$ , and if  $X$  is a normal space, then the Brouwer-Čech dimension of  $X$  is denoted by  $\text{Ind}(X)$  (see, e.g., [19, Chapter 7] for a detailed account of these three dimension functions). Also, for a spectral space  $X$ , let  $\text{kdim}(X)$  denote the Krull dimension of  $X$ , and for a  $T_0$ -space  $X$ , let  $\text{gdim}(X)$  denote Isbell's graduated dimension of  $X$  [29].

**PROPOSITION 7.1.** *Let  $X$  be a topological space.*

1. *If  $X$  is a spectral space, then  $\text{kdim}(X) \leq \text{mdim}(X)$ .*
2. *If  $X$  is a  $T_0$ -space, then  $\text{gdim}(X) \leq \text{mdim}(X)$ .*
3. *If  $X$  is a regular space, then  $\text{ind}(X) \leq \text{mdim}(X)$ .*
4. *If  $X$  is a normal space, then  $\text{Ind}(X) \leq \text{mdim}(X)$  and  $\text{dim}(X) \leq \text{mdim}(X)$ .*

**PROOF.** (1) The Krull dimension of a spectral space  $X$  can be defined as the supremum of the lengths of finite chains in the specialization order  $R$  of  $X$ . Define  $\varepsilon : X \rightarrow (\mathfrak{A}_X)_*$  by  $\varepsilon(x) = \{A \in \mathfrak{A}_X \mid x \in A\}$ . It is well known and easy to check that  $xRy$  in  $X$  iff  $\varepsilon(x)R\varepsilon(y)$  in  $(\mathfrak{A}_X)_*$ . Therefore, the supremum of the lengths of finite chains in the specialization order of  $X$  can be no larger than the supremum of the lengths of finite chains in  $(\mathfrak{A}_X)_*$ . The result follows.

(2) Recall that Isbell's graduated dimension of a  $T_0$ -space  $X$  is the least  $n$  such that some lattice basis of  $\mathfrak{H}_X$  is a directed union of finite topologies of Krull dimension  $n$ . Suppose the Isbell dimension of  $X$  is  $n$ . The lattice of all opens  $\mathfrak{H}_X$  is a directed union of finite topologies  $\tau_i$  since the variety of distributive lattices is locally finite. Because the Krull dimension of each  $\tau_i$  is  $\geq n$ , we see that  $\text{mdim}(X) \geq n$ , as desired.

(3) Induction on  $n \geq -1$ . The base case is clear since  $\text{ind}(X) = -1$  iff  $X = \emptyset$ , which happens iff  $\text{mdim}(X) = -1$ . For the inductive step, suppose  $\text{mdim}(X) = n$ . If  $Y$  is closed and nowhere dense in  $X$ , then  $\text{mdim}(Y) \leq n - 1$ . By the inductive hypothesis,  $\text{ind}(Y) \leq n - 1$ . Because the boundary of an open set is (closed and) nowhere dense in  $X$ , it follows that the boundary  $B$  of any open subset of  $X$  has  $\text{ind}(B) \leq n - 1$ . Thus,  $\text{ind}(X) \leq n$ .

(4) Let  $X$  be normal. Replacing each occurrence of  $\text{ind}$  in the proof of (3) by  $\text{Ind}$  yields  $\text{Ind}(X) \leq \text{mdim}(X)$ . By [19, Theorem 7.2.8],  $\text{dim}(X) \leq \text{Ind}(X) \leq \text{mdim}(X)$ . ◻

**REMARK 7.2.**

- It remains open whether  $\text{dim}(X) \leq \text{mdim}(X)$  for any Tychonoff space  $X$ .
- For appropriately chosen spaces, the inequalities in Proposition 7.1 are strict. For example, if  $X = \omega^n + 1$ , then  $\text{kdim}(X) = \text{gdim}(X) = \text{ind}(X) = \text{Ind}(X) = \text{dim}(X) = 0$ , but  $\text{mdim}(X) = n$  by Example 3.7(3).

**§8. Acknowledgments.** We are very thankful to the referees. Their careful reading and detailed comments have improved both the presentation and the proofs considerably. In addition, one of the referees suggested a more convenient version of the formulas  $\text{zem}_n$ , which coupled with Sahlqvist correspondence, have simplified a number of proofs in Section 4. The first two authors acknowledge the support of Shota Rustaveli National Science Foundation grant #DI-2016-25.



## REFERENCES

- [1] J. VAN BENTHEM and G. BEZHANISHVILI, *Modal logics of space*, **Handbook of Spatial Logics** (M. Aiello, I. Pratt-Hartmann, and J. van Benthem, editors), Springer, Dordrecht, 2007, pp. 217–298.
- [2] J. VAN BENTHEM, N. BEZHANISHVILI, and I. HODKINSON, *Sahlqvist correspondence for modal mu-calculus*, **Studia Logica**, vol. 100 (2012), pp. 31–60.
- [3] G. BEZHANISHVILI, L. ESAKIA, and D. GABELAIA, *Some results on modal axiomatization and definability for topological spaces*, **Studia Logica**, vol. 81 (2005), pp. 325–355.
- [4] G. BEZHANISHVILI, D. GABELAIA, and M. JIBLADZE, *Spectra of compact regular frames*, **Theory and Applications of Categories**, vol. 31 (2016), pp. 365–383.
- [5] G. BEZHANISHVILI, D. GABELAIA, and J. LUCERO-BRYAN, *Modal logics of metric spaces*, **Review of Symbolic Logic**, vol. 8 (2015), pp. 178–191.
- [6] P. BLACKBURN, M. DE RIJKE, and Y. VENEMA, **Modal Logic**, Cambridge University Press, Cambridge, 2001.
- [7] W. BLOK, *Varieties of interior algebras*, Ph.D. thesis, University of Amsterdam, 1976.
- [8] A. BOILEAU and A. JOYAL, *La logique des topos*, this JOURNAL, vol. 46 (1981), pp. 6–16.
- [9] S. B. CHAE and J. H. SMITH, *Remote points and G-spaces*, **Topology and its Applications**, vol. 11 (1980), pp. 243–246.
- [10] A. CHAGROV and M. ZAKHARYASCHEV, **Modal Logic**, Oxford University Press, New York, 1997.
- [11] T. COQUAND and H. LOMBARDI, *Hidden constructions in abstract algebra: Krull dimension of distributive lattices and commutative rings*, **Commutative Ring Theory and Applications (Fez, 2001)** (M. Fontana, S.-E. Kabbaj, and S. Wiegand, editors), Lecture Notes in Pure and Applied Mathematics, vol. 231, Dekker, New York, 2003, pp. 477–499.
- [12] T. COQUAND, H. LOMBARDI, and M.-F. ROY, *An elementary characterization of Krull dimension*, **From Sets and Types to Topology and Analysis** (L. Crosilla and P. Schuster, editors), Oxford Logic Guides, vol. 48, Oxford University Press, Oxford, 2005, pp. 239–244.
- [13] E. K. VAN DOUWEN, *Remote points*, **Dissertationes Mathematicae (Rozprawy Matematyczne)**, vol. 188 (1981), 45 pages.
- [14] ———, *Applications of maximal topologies*, **Topology and its Applications**, vol. 51 (1993), pp. 125–139.
- [15] A. DOW, *Remote points in large products*, **Topology and its Applications**, vol. 16 (1983), pp. 11–17.
- [16] A. DOW and J. VAN MILL, *On  $n$ -to-one continuous images of  $\beta\mathbb{N}$* , **Studia Scientiarum Mathematicarum Hungarica**, vol. 44 (2007), pp. 355–366.
- [17] F. W. ECKERTSON, *Resolvable, not maximally resolvable spaces*, **Topology and its Applications**, vol. 79 (1997), pp. 1–11.
- [18] D. EISENBUD, **Commutative Algebra**, Graduate Texts in Mathematics, vol. 150, Springer-Verlag, New York, 1995.
- [19] R. ENGELKING, **General Topology**, second ed., Heldermann Verlag, Berlin, 1989.
- [20] L. ESAKIA, *Topological Kripke models*, **Soviet Mathematics Doklady**, vol. 15 (1974), pp. 147–151.
- [21] ———, *Heyting Algebras I. Duality Theory*, “Metsniereba”, Tbilisi, 1985, (In Russian).
- [22] L. ESPAÑOL, *Constructive Krull dimension of lattices*, **Revista de la Academia de Ciencias Exactas, Físico-Químicas y Naturales de Zaragoza, Serie 2**, vol. 37 (1982), pp. 5–9.
- [23] ———, *Finite chain calculus in distributive lattices and elementary Krull dimension*, **Scientific Contributions in Honor of Mirian Andrés Gómez** (L. Lambán, A. Romero, and J. Rubio, editors), University of La Rioja, Logroño, 2010, pp. 273–285.
- [24] K. FINE, *An ascending chain of S4 logics*, **Theoria**, vol. 40 (1974), pp. 110–116.
- [25] M. C. FITTING, **Intuitionistic Logic, Model Theory and Forcing**, Studies in Logic and the Foundations of Mathematics, North-Holland Publishing Co., Amsterdam-London, 1969.
- [26] A. M. GLEASON, *Projective topological spaces*, **Illinois Journal of Mathematics**, vol. 2 (1958), pp. 482–489.
- [27] R. I. GOLDBLATT, *Metamathematics of modal logic*, **Reports on Mathematical Logic**, vol. 6 (1976), pp. 41–77.
- [28] A. HATCHER, **Algebraic Topology**, Cambridge University Press, Cambridge, 2002.
- [29] J. ISBELL, *Graduation and dimension in locales*, **Aspects of Topology**, London Mathematical Society Lecture Note Series, vol. 93, Cambridge University Press, Cambridge, 1985, pp. 195–210.

- [30] V. JANKOV, *On the relation between deducibility in intuitionistic propositional calculus and finite implicative structures*. *Doklady Akademii Nauk SSSR*, vol. 151 (1963), pp. 1293–1294 (In Russian).
- [31] B. JÓNSSON and A. TARSKI, *Boolean algebras with operators. I*. *American Journal of Mathematics*, vol. 73 (1951), pp. 891–939.
- [32] I. JUHÁSZ, *Cardinal Functions in Topology*, Mathematical Centre Tracts, vol. 34, Mathematisch Centrum, Amsterdam, 1971.
- [33] ———, *Cardinal Functions in Topology—Ten Years Later*, second ed., Mathematical Centre Tracts, vol. 123, Mathematisch Centrum, Amsterdam, 1980.
- [34] S. A. KRIPKE, *Semantical analysis of modal logic. I. Normal modal propositional calculi*. *Zeitschrift für Mathematische Logik und Grundlagen der Mathematik*, vol. 9 (1963), pp. 67–96.
- [35] L. MAKSIMOVA, *Modal logics of finite layers*. *Algebra and Logic*, vol. 14 (1975), pp. 188–197.
- [36] J. C. C. MCKINSEY, *A solution of the decision problem for the Lewis systems  $S_2$  and  $S_4$ , with an application to topology*, this JOURNAL, vol. 6 (1941), pp. 117–134.
- [37] J. C. C. MCKINSEY and A. TARSKI, *The algebra of topology*. *Annals of Mathematics*, vol. 45 (1944), pp. 141–191.
- [38] ———, *On closed elements in closure algebras*. *Annals of Mathematics*, vol. 47 (1946), pp. 122–162.
- [39] J. VAN MILL and C. F. MILLS, *A boojum and other snarks*. *Indagationes Mathematicae*, vol. 42 (1980), pp. 419–424.
- [40] S. NEGREPONTIS, *Absolute Baire sets*. *Proceedings of the American Mathematical Society*, vol. 18 (1967), pp. 691–694.
- [41] J. R. PORTER and R. G. WOODS, *Extensions and Absolutes of Hausdorff Spaces*, Springer-Verlag, New York, 1988.
- [42] H. RASIOWA and R. SIKORSKI, *The Mathematics of Metamathematics*, Monografie Matematyczne, Tom 41, Państwowe Wydawnictwo Naukowe, Warsaw, 1963.
- [43] K. SEGERBERG, *An Essay in Classical Modal Logic*, Filosofiska Studier, No. 13, Filosofiska Föreningen och Filosofiska Institutionen vid Uppsala Universitet, Uppsala, 1971.
- [44] M. STONE, *Topological representation of distributive lattices and Brouwerian logics*. *Časopis Pro Pěstování Matematiky a Fysiky*, vol. 67 (1937), pp. 1–25.
- [45] T. TSAO-CHEN, *Algebraic postulates and a geometric interpretation for the Lewis calculus of strict implication*. *Bulletin of the American Mathematical Society*, vol. 44 (1938), pp. 737–744.
- [46] R. C. WALKER, *The Stone-Čech Compactification*, Springer-Verlag, New York-Berlin, 1974.
- [47] S. WILLARD, *General Topology*, Dover Publications, Inc., Mineola, NY, 2004.

DEPARTMENT OF MATHEMATICAL SCIENCES  
 NEW MEXICO STATE UNIVERSITY  
 LAS CRUCES, NM 88003, USA  
*E-mail:* guram@math.nmsu.edu

INSTITUTE FOR LOGIC, LANGUAGE AND COMPUTATION  
 UNIVERSITY OF AMSTERDAM  
 1090 GE AMSTERDAM, THE NETHERLANDS  
*E-mail:* n.bezhanishvili@uva.nl

DEPARTMENT OF APPLIED MATHEMATICS AND SCIENCES  
 KHALIFA UNIVERSITY  
 PO 127788 ABU DHABI, UAE  
*E-mail:* joel.lucero-bryan@kustar.ac.ae

KORTEWEG-DE VRIES INSTITUTE FOR MATHEMATICS  
 UNIVERSITY OF AMSTERDAM  
 1098 XG AMSTERDAM, THE NETHERLANDS  
*E-mail:* j.vanmill@uva.nl